

EAGLE GROUP

A Division of AIMCO

POWER TOOL SOLUTIONS

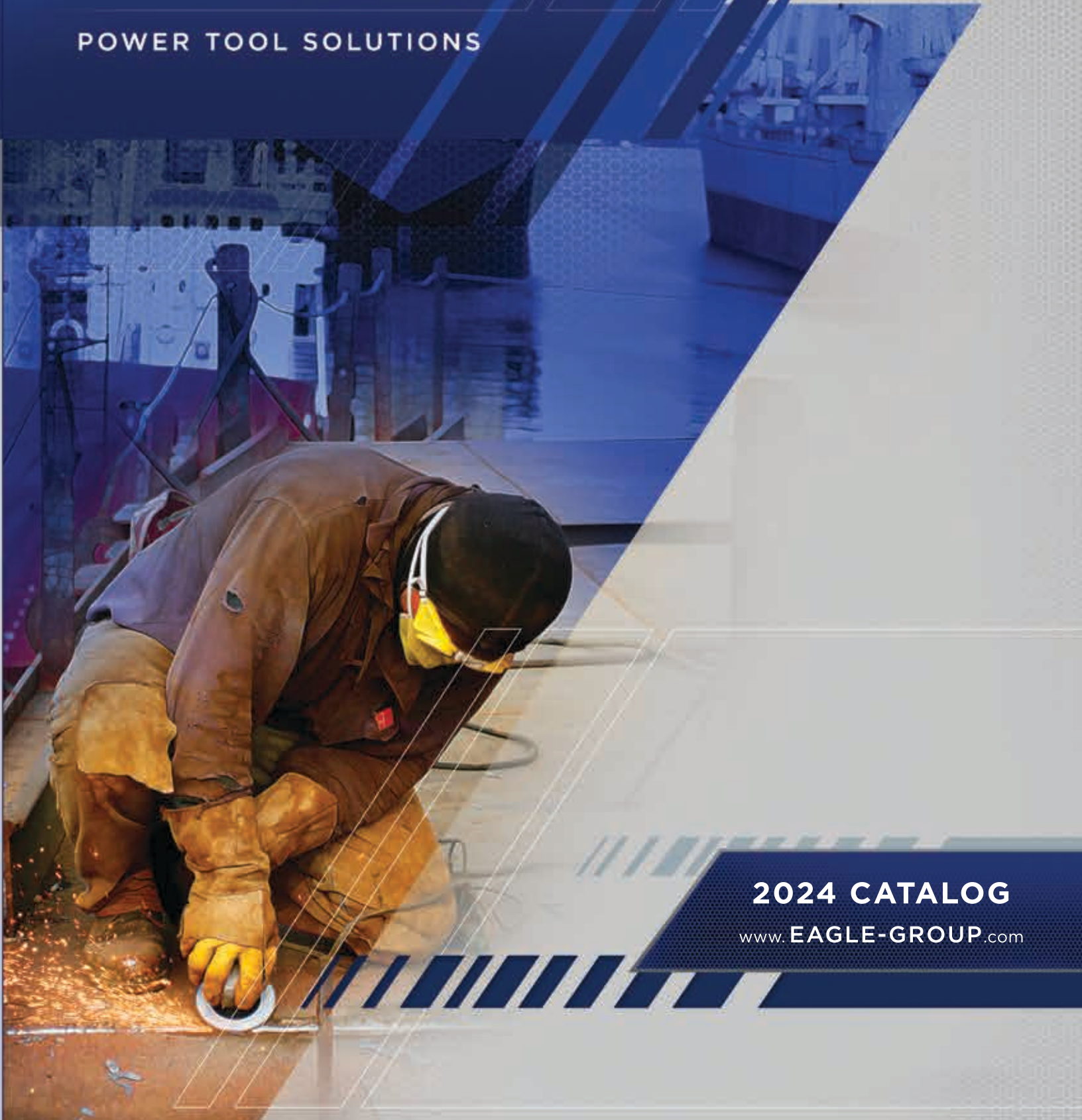

2024 CATALOG

www.EAGLE-GROUP.com

5	GRINDERS
13	SANDERS
17	IMPACT WRENCHES
21	RATCHET WRENCHES
23	ASSEMBLY TOOLS
31	DRILLS
35	PERCUSSION TOOLS
39	CUTTING & SPECIALTY TOOLS
43	ACCESSORIES
61	RESOURCES



>> ABOUT EAGLE GROUP

Eagle Group is a leading supplier of power tools for industrial markets. Whether you need tools for material removal, finishing, maintenance, automotive, or assembly, Eagle Group has your solution.

Eagle Group has been a supplier of power tools for over 30 years throughout the United States, Mexico, and South America.

Located in Portland, Oregon, Eagle resides in AIMCO's corporate complex.



EAGLE GROUP THE EAGLE GROUP **DIFFERENCE**

EAGLE GROUP

A portfolio designed for a variety of customers and customer use requirements

- Economic tool series for limited use, limited maintenance, or limited budget
- Ergonomic series for safer and more comfortable use
- Industrial and Premier series for specific process and safety improvements
- All supported under the AIMCO umbrella of service and support

CALL TODAY TOLL FREE:
(800) 852-1368

MATERIAL REMOVAL

5040
Vertical
Grinder



5205-2EC
Angle Grinder



5002C
Die Grinder



5I-10202X Extended Die Grinder



5000 Pencil Grinder



5I-06251 Heavy Duty Steel Grinder

BOLTING

High Torque Pneumatic



AAP1B Series



AAP2B
High-Speed Series



DynaTorque
Manual Torque
Multipliers ATM-3800

CUTTING



6080 Reciprocating Saw



6050
Reciprocating Saw



5G-10125
5" Angle Saw

IMPACT WRENCHES

2010
3/8"
Single Hammer



2260L
1/2" Twin Pin



2P-155034
3/4" Twin Hammer



2450 1" Twin Hammer



2450L 1" Twin Hammer



2S-290015
1-1/2" Swing Hammer

LIGHT ASSEMBLY



1115 Positive Clutch
Screwdriver



1101 Stall Screwdriver



1102 Adjustable
Clutch Screwdriver



1577 Impact
Screwdriver

FINISHING

6906EC Orbital
Sander



6134EC
Angle Sander



6116 Belt Sander



PERCUSSION

4009 Chipping Hammer



4100 Air Hammer



4005 Needle
Scaler



4004 Flux Chipper



DRILLING/TAPPING

738P-3200 Drill



7650 Angle Drill



7110 Reversible Drill



CORDLESS ASSEMBLY

Signature Series Cordless



SPC Series
Precision
Clutch



SIW Series
Shut-off Impact



GRINDERS

GRINDERS

From precise pencil grinders and die grinders to large vertical grinders,

Eagle Group has the right tool for your application. With a wide variety of horsepower ratings, RPMs, guards, and collet sizes, Eagle Group grinders excel in many applications, including blending, smoothing, cleaning, weld preparation, and deburring in maintenance, fabrication, and construction markets.

STRAIGHT DIE GRINDERS

GRINDERS

5I-03302

1/4" Steel Die Grinders

INDUSTRIAL DUTY



0.3 HP

5I-03302F



FRONT EXHAUST

0.3 HP

- Lightweight design with smooth performance
- Erickson collet precisely grips attachments resulting in minimal runout
- Safety lockout throttle lever prevents accidental start

5000

1/8" Pencil Grinder

GENERAL DUTY

- Excellent for blending/finishing work
- High-speed precision
- Complete with air hose, exhaust hose, and integral silencer



0.1 HP

5000

Application	General
Housing	Aluminum
Collet Size	1/8"
Approx. Power (hp)	0.1
Approx. Speed (rpm)	54,000
Throttle Type	Twist
Exhaust	Rear hose
Weight	0.6 lb / 0.3 kg
Length	5.3" / 133 mm
Air Usage (cfm)	6
Air Inlet	1/4"

5001

1/4" Steel Die Grinder

GENERAL DUTY

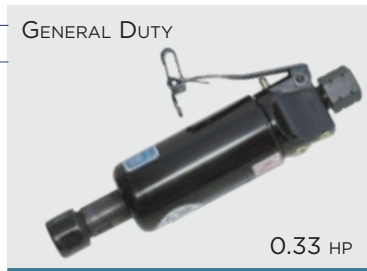

0.33 HP

- All steel housing
- Built-in regulator
- 1/8" collet available

5110

1/4" Aluminum Mini Die Grinder

GENERAL DUTY

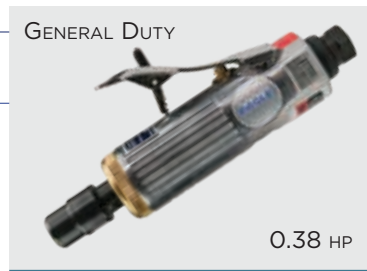

0.38 HP

- Good for light weld grinding, polishing, and breaking sharp edges
- Air regulator allows operator to control speed

5002C

1/4" Aluminum Die Grinder

GENERAL DUTY



0.33 HP

- Compact and lightweight
- All ball-bearing construction
- Rib textured handle provides firm grip
- For blending, smoothing, and porting
- 1/8" collet available (part #32046-31-02)
- Alternative to MSI-Pro SM512

Model	Application	Housing	Collet Size	Approx. Power (hp)	Approx. Speed (rpm)	Throttle Type	Exhaust	Weight		Length		Air Usage (cfm)	Air Inlet
								lb	kg	in	mm		
5I-03302	Industrial	Steel	1/4"	0.3	30,000	Lever	Rear	1	0.45	6.5	165	20	1/4"
5I-03302F	Industrial	Steel	1/4"	0.3	30,000	Lever	Front	1	0.45	6.5	165	20	1/4"
5001	General	Steel	1/4"	0.33	18,000	Lever	Front	1.3	0.6	6.5	165	14	1/4"
5002C	General	Aluminum	1/4"	0.33	22,000	Lever	Rear	1.2	0.5	6.9	175	14	1/4"
5110	General	Aluminum	1/4"	0.38	25,000	Lever	Rear	0.8	0.4	4.8	122	14	1/4"

5201EC 5200EC 1/4" Composite Die Grinders

GENERAL DUTY

Mini Grinder



0.5 HP

0.75 HP

- Lightweight and durable
- Ergonomic composite housing with a soft comfortable grip
- For blending, smoothing, and sanding
- Less noise, vibration, and thermal transfer than aluminum tools

5I-04252 5I-06222 1/4" Composite Die Grinders

INDUSTRIAL DUTY



0.4 HP

0.6 HP

- Lightweight design with smooth performance
- Erickson collet precisely grips attachments resulting in minimal runout
- Safety lockout throttle lever prevents accidental tool start

Model	Application	Housing	Collet Size	Approx. Power (hp)	Approx. Speed (rpm)	Throttle Type	Exhaust	Weight		Length		Air Usage (cfm)	Air Inlet
								lb	kg	in	mm		
5201EC	General	Composite	1/4"	0.5	25,000	Lever	Rear	0.8	0.36	6.25	159	12	1/4"
5200EC	General	Composite	1/4"	0.75	22,000	Lever	Rear	1.3	0.59	6.75	171	14	1/4"
5I-04252	Industrial	Composite	1/4"	0.4	25,000	Lever	Rear	1	0.46	7	179	25	1/4"
5I-06222	Industrial	Composite	1/4"	0.6	22,000	Lever	Rear	1.58	0.72	7.8	198	30	1/4"

1/4" HEAVY-DUTY STEEL DIE GRINDERS

5I-06251

5I-10202

INDUSTRIAL DUTY

Compact



0.6 HP

1.0 HP

- Heavy-duty steel housing
- Erickson collet precisely grips attachments for long-lasting, minimal runout
- Safety lockout throttle lever prevents accidental tool start
- 5I-10202: Governed air motor for safe use and maximum power and speed under load

Model	Application	Housing	Collet Size	Approx. Power (hp)	Approx. Speed (rpm)	Throttle Type	Exhaust	Weight		Length		Air Usage (cfm)	Air Inlet
								lb	kg	in	mm		
5I-06251	Industrial	Steel	1/4"	0.6	25,000	Lever	Front	1.45	0.66	6.5	165	19	1/4"
5I-10202	Industrial	Steel	1/4"	1.0	20,000	Lever	Front	2.82	1.28	7.9	201	35	3/8"

EXTENDED DIE GRINDERS

5206EC (3") / 5207EC (5") 1/4" Composite Die Grinders, 3" & 5" Extended

GENERAL DUTY



0.6 HP



0.6 HP

- Lightweight and durable
- Extended length for hard-to-reach areas
- Ergonomic composite housing with a soft comfortable grip
- For blending, smoothing, and porting
- Less noise, vibration, and thermal transfer than aluminum tools

1/4" COMPOSITE HEAVY-DUTY DIE GRINDERS, 5" EXTENDED

5I-04252X

5I-06202X

INDUSTRIAL DUTY



0.4 HP



0.6 HP

- Lightweight design with smooth performance
- Erickson collet precisely grips attachments resulting in minimal runout
- Safety lockout throttle lever prevents accidental start

5116 1/4" Aluminum Die Grinder, 6" Extended

GENERAL DUTY

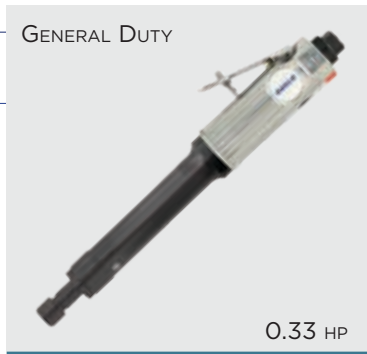

0.33 HP

- All ball-bearing construction
- Extended length for hard-to-reach areas
- Rib textured handle provides firm grip
- For blending, smoothing, and porting

5I-10202X 1/4" Steel Die Grinder, 6" Extended

INDUSTRIAL DUTY



1.0 HP

- 1/4" Erickson collet precisely grips attachments for long-lasting, minimal runout
- Robust safety lever and all-steel body construction
- Double bearing supported spindle
- Full 1 HP governed air motor for safe use and maximum power and speed under load

Model	Application	Housing	Extension	Collet Size	Approx. Power (hp)	Approx. Speed (rpm)	Throttle Type	Exhaust	Weight		Length		Air Usage (cfm)	Air Inlet
									lb	kg	in	mm		
5206EC	General	Composite	3"	1/4"	0.6	25,000	Lever	Rear	1.43	0.65	9.25	235	12	1/4"
5207EC	General	Composite	5"	1/4"	0.6	25,000	Lever	Rear	1.45	0.66	11.25	286	12	1/4"
5I-04252X	Industrial	Composite	5"	1/4"	0.4	25,000	Lever	Rear	1.4	3.08	12.2	309	25	1/4"
5I-06202X	Industrial	Composite	5"	1/4"	0.6	20,000	Lever	Rear	2.31	1.05	13.03	331	30	1/4"
5116	General	Aluminum	6"	1/4"	0.33	22,000	Lever	Rear	2.75	1.2	13.0	305	14	1/4"
5I-10202X	Industrial	Steel	6"	1/4"	1	20,000	Lever	Rear	4.5	2	14.5	368	35	3/8"

ANGLE DIE GRINDERS

5004C

1/4" Gearless Angle Die Grinder

- Lower vibration than standard right-angle die grinders
- No reduction in performance due to gear wear
- No gear replacement needed
- Cylinder constructed of high quality steel
- Variable speed throttle for positive speed control
- For general high-speed polishing and grinding
- Alternative to MSI-Pro SM524



5003C

1/4" Aluminum Angle Die Grinder

- Compact lightweight design
- Ball-bearing construction
- For sanding, deburring, and polishing
- Right angle provides easy access

GENERAL DUTY



5A-04122 / 5A-04202

1/4" Composite Angle Die Grinder

- Lightweight design with smooth performance
- Erickson collet precisely grips attachments resulting in minimal runout
- Safety lockout throttle lever prevents accidental start



5202EC

1/4" Composite Angle Die Grinder, 90°

GENERAL DUTY



5203EC

1/4" Composite Angle Die Grinder, 105°



- Lightweight and durable
- Ergonomic composite housing with a soft comfortable grip
- Less noise, vibration, and thermal transfer than aluminum tools
- Right angle provides easy access
- For sanding, polishing, deburring, and porting

Model	Application	Housing	Collet Size	Approx. Power (hp)	Approx. Speed (rpm)	Throttle Type	Exhaust	Weight		Length		Air Usage (cfm)	Air Inlet
								lb	kg	in	mm		
5003C	General	Aluminum	1/4"	0.33	20,000	Lever	Rear	1.0	0.5	6.3	159	14	1/4"
5004C	General	Aluminum	1/4"	0.3	25,000	Lever	Rear	1.1	0.5	6.7	170	2.7	1/4"
5A-04122	Industrial	Composite	1/4"	0.4	12,000	Lever	Rear	1.3	0.59	7.2	182	20	1/4"
5A-04202	Industrial	Composite	1/4"	0.4	20,000	Lever	Rear	1.3	0.59	7.2	182	19	1/4"
5202EC 5203EC	General	Composite	1/4"	0.6	20,000	Lever	Rear	1.1	0.55	6.25	159	12	1/4"

ANGLE GRINDERS

5A-0514-2

2" Steel Angle Grinder

- Robust, steel design for harsh use environments
- 2" angle head designed for limited access and ease of maneuverability
- Adjustable guard rotation for best protection



5205-2EC

3" Composite Angle Grinder, 105°

- Ergonomic and safe use design
- 105° angled head design provides improved sight lines and spark angle
- Tight access use
- 1/16" to 1/4" wheel capability



5006 (4") / 5007 (5")

4" & 5" Aluminum Angle Grinders

- Governed motor
- 5/8"-11 adapter included
- Uses Type 27 wheels, abrasive discs
- Spiral bevel gearing for extended life, low vibration
- For weld prep, smoothing, rust removal, and deburring
- Lightweight aluminum alloy housing



5194EC / 5194EC-KIT (4")

5195EC / 5195EC-KIT (4.5")

5196EC / 5196EC-KIT (5")

Composite Angle Grinders

- Swivel guard adjustable in nine steps
- Composite body, spindle lock, rear exhaust, quiet operation
- Reversible side handle
- Governed motor
- KIT models include an Ergo Handle and a Quick Nut

INDUSTRIAL DUTY



	5194EC	5195EC	5196EC
Application	Industrial		
Wheel Capacity	4"	4.5"	5"
Housing	Composite		
Spindle	3/8"-24	5/8"-11	5/8"-11
Approx. Power (hp)	1.3		
Approx. Speed (rpm)	12,000		
Throttle Type	Lever		
Exhaust	Rear		
Weight	3.8 lb / 1.72 kg		
Length	9.6" / 244 mm		
Air Usage (cfm)	25		
Air Inlet	1/4"		

ACCESSORIES

8101

Ergo Handle

- Dramatically reduces vibration
- For models 5194EC, 5195EC, and 5196EC



8102 / 8103

Quick Nut

- Eliminates spanner wrench
- #8102 for 5/8"-11 spindle (5195EC & 5196EC)
- #8103 for 3/8"-24 spindle (5194EC)

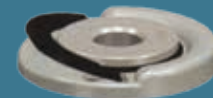

Model	Application	Housing	Wheel Capacity	Spindle	Approx. Power (hp)	Approx. Speed (rpm)	Throttle Type	Exhaust	Weight		Length		Air Usage (cfm)	Air Inlet
									lb	kg	in	mm		
5A-0514-2	Industrial	Steel	2"	3/8"-24	0.5	14,000	Lever	Side	3	1.4	8.5	216	15	1/4"
5205-2EC	General	Composite	3"	3/8" shaft	0.6	15,000	Lever	Rear	1.5	0.68	8.25	210	12	1/4"
5006	General	Aluminum	4"	3/8"-24*	0.6	11,000	Lever	Front right	4	1.8	9.5	241	18	1/4"
5007	General	Aluminum	5"	3/8"-24*	0.6	11,000	Lever	Front right	4.3	1.8	9.5	241	18	1/4"

* 5/8"-11 adapter included

ANGLE GRINDERS



5104 (4") / 5105 (5") 4" & 5" Sandcast Aluminum Angle Grinders

- All steel internal parts
- Four-step heat treat process
- Sandcast aluminum housing
- Uses Type 27 wheels and abrasive discs

5A-1012-5 5" Aluminum Angle Grinder



- Low profile angle head and sleek design for comfort and maneuverability
- Sandcast head and steel collar for robust construction and heavy use
- Machined aluminum body for light weight and durability
- Deep cut bevel gears for long-lasting transmission of power and lower vibration
- Left/right hand use
- Governed motor for constant speed
- Safety start lever
- Rear exhaust

5008H 7" Aluminum Angle Grinder



- Governed motor
- Aluminum alloy housing
- Spiral bevel gear angle head for long tool life
- For cleaning, deburring, notching, and grinding

5A-1676-7 7" Sandcast Aluminum Angle Grinder



- All steel internal parts
- Four-step heat treat process
- Sandcast aluminum housing
- Uses Type 27 wheels and abrasive discs

Model	Application	Housing	Wheel Capacity	Spindle	Approx. Power (hp)	Approx. Speed (rpm)	Throttle Type	Exhaust	Weight		Length		Air Usage (cfm)	Air Inlet
									lb	kg	in	mm		
5104	Industrial	Sandcast aluminum	4"	3/8"-24	1	13,500	Pushbutton/lever	Front right	4.4	2	8.3	211	34	1/4"
5105	Industrial	Sandcast aluminum	5"	5/8"-11	1	10,800	Pushbutton/lever	Front right	4.4	2	8.3	211	34	1/4"
5A-1012-5	Industrial	Aluminum	5"	5/8"-11	1	12,000	Lever	Rear	4.0	1.8	11	279	30	3/8"
5008H	General	Aluminum	7"	5/8"-11	1.1	7,000	Pushbutton/lever	Bottom	7.0	3.2	13.5	343	34	3/4"
5A-1676-7	Industrial	Sandcast aluminum	7"	5/8"-11	1.6	7,600	Lever	Front right	6.6	3	11.8	300	56	3/8"

VERTICAL GRINDERS

5040-6 (6") / 5040 (7") / 5040-9 (9")
 6" / 7" / 9" Aluminum Vertical Grinders

INDUSTRIAL DUTY



5040 / 5040-9

- 3 HP governed motor
- Durable aluminum housing
- Safety throttle

3.0 HP

5040-6

	5040-6	5040	5040-9
Application	Industrial		
Housing	Aluminum		
Wheel Capacity	6"	7"	9"
Spindle	5/8"-11		
Approx. Power (hp)	3.0		
Approx. Speed (rpm)	6,000		
Throttle Type	Pushbutton / lever		
Exhaust	Side/directional		
Weight	7.7 lb / 3.5 kg		
Length	12" / 305 mm		
Air Usage (cfm)	49		
Air Inlet	1/2"		

5040-7G
7" GUARD



5040-6CG
6" CUP GUARD



5040-9G
9" GUARD



SANDERS SANDERS

*A perfect mix
of dependability,
features, and value,*

Eagle Group sanders and
polishers are ideal for a wide
range of finishing and refinishing
applications, including auto paint &
body shops, wood working shops,
fiberglass finishers, and general industry.

ANGLE SANDERS & POLISHER

2" COMPOSITE SERIES ANGLE SANDERS

- Lightweight and durable
- Ergonomic composite housing with a soft comfortable grip
- Less noise, vibration, and thermal transfer than aluminum tools

6133EC Angle Sander, 90°

GENERAL DUTY



15,000 RPM

6134EC Angle Sander, 105°

GENERAL DUTY



6115EC Angle Orbital Sander, 105°

GENERAL DUTY



15,000 RPM

- Pad Size: 2" Diameter, M6 x 1.0 thread, yellow polyurethane foam pad, hooked Velcro face
- Orbital Capacity: 0.2" / 3.0 mm

- 6133EC and 6134EC with roll lock abrasive holder

Model	Application	Housing	Sanding Disc	Pad Size	Spindle	Approx. Power (hp)	Approx. Speed (rpm)	Weight		Length		Air Usage (cfm)	Air Inlet
								lb	kg	in	mm		
6133EC	General	Composite	2"	1.75"	1/4"-20	0.25	15,000	1.05	0.48	6.75	171	12	1/4"
6134EC	General	Composite	2"	1.75"	1/4"-20	0.25	15,000	1.05	0.48	6.75	171	12	1/4"
6115EC	General	Composite	2"	2"	1/4"-20	0.3	15,000	1.36	0.62	6.75	171	12	1/4"

6012 7" Aluminum Angle Sander

- Powerful 1 hp motor
- Dead handle mounts either side
- Hardened and ground spiral bevel gears for long life
- For heavy rust removal, sanding, and shaping of filler patches

GENERAL DUTY



4,500 RPM

6507 7" Aluminum Angle Polisher

- Built-in power regulator
- Dead handle for easy control
- Ideal for buffing and polishing paint and metal to a professional finish

GENERAL DUTY



2,500 RPM

Model	Application	Housing	Sanding Disc	Pad Size	Spindle	Approx. Power (hp)	Approx. Speed (rpm)	Weight		Length		Air Usage (cfm)	Air Inlet
								lb	kg	in	mm		
6012	General	Aluminum	7"	7"	5/8"-11	1	4,500	6	2.7	15	381	19	1/4"
6507	General	Aluminum	7"	7"	5/8"-11	0.25	2,500	6.5	2.9	18	457	12	1/4"

ORBITAL & JITTERBUG SANDERS

6905EC (5") / 6906EC (6")

5" & 6" Composite Random Orbital Sanders

INDUSTRIAL DUTY



12,000 RPM

- Vibration absorbing grip
- High power and lightweight
- PSA pad type
- Orbital action assures swirl-free finish
- For touch-up, feather-edging, sanding, pre-paint preparation

6905EC **6906EC**

Application	Industrial	
Housing	Composite	
Pad Size	5"	6"
Spindle	5/16"-24	
Orbit	3/16" pattern	
Approx. Power (hp)	0.25	
Approx. Speed (rpm)	12,000	
Weight	2 lb / 0.9 kg	
Length	6.9" / 175 mm	
Air Usage (cfm)	15	
Air Inlet	1/4"	

6005

6" Aluminum Dual-Action Orbital Sander

- Dual action
- Built-in regulator
- Insulated grip
- Lightweight all aluminum body construction
- For touch-up, feather-edging, sanding, and pre-paint preparation

GENERAL DUTY



10,000 RPM

6009

Jitterbug Sander

- Durable construction
- For wet and dry sanding
- For wood, metal, or plastic finishing and fiberglass

GENERAL DUTY



8,000 RPM

Model	Application	Housing	Pad Size	Spindle	Orbit	Approx. Power (hp)	Approx. Speed (rpm)		Weight		Length		Air Usage (cfm)	Air Inlet
									lb	kg	in	mm		
6005	General	Aluminum	6"	5/16"-24	5/16" pattern	0.25	10,000		5.2	2.1	12	305	16	1/4"
6009	General	Aluminum	3.5 x 7.75 in 89 x 197 mm	—	—	0.25	8,000		4.3	2	8	203	15	1/4"

HIGH-SPEED, BOARD, & BELT SANDERS

6113 3" - 5" High-Speed Sander

- Lightweight, compact design
- Includes 3" & 5" backing pads
- Built-in regulator to control speed
- For paint removal, shaping filler patches, weld smoothing, rust removal

GENERAL DUTY



18,000 RPM

6017 Two-Piston Board Sander

- Two handle design
- Smooth feathers; dual pistons provide efficient power and prevent stalling
- For all types of surface preparation and rapid removal of material from large areas

GENERAL DUTY



3,300 RPM

Model	Application	Housing	Pad Size	Spindle	Approx. Power (hp)	Approx. Speed (rpm)	Weight		Length		Air Usage (cfm)	Air Inlet
							lb	kg	in	mm		
6113	General	Aluminum	3" / 5"	3/8"	0.25	18,000	2.4	1.1	4.6	117	19	1/4"
6017	General	Aluminum	2.5 x 15.75 in 63 x 400 mm	—	0.75	3,300	6.87	3	16	406	9	1/4"

ALUMINUM BELT SANDERS

- Best for sanding confined areas and curved surfaces
- Adjustable sanding belt rotates to allow easy handling
- Quick-change belt replacement

Model	Application	Housing	Belt Size		Approx. Power (hp)	Approx. Speed (rpm)	Weight		Length		Air Usage (cfm)	Air Inlet
			in	mm			lb	kg	in	mm		
6114	General	Aluminum	3/8 x 13	10 x 305	0.33	16,000	1.7	0.8	10.5	267	14	1/4"
6115	General	Aluminum	1/2 x 24	13 x 610	0.33	16,000	1.7	0.8	23.5	597	14	1/4"
6116	General	Aluminum	3/4 x 20.5	20 x 520	0.4	16,000	3.1	1.4	11.9	302	18	1/4"

6114

6115

6116

GENERAL DUTY



16,000 RPM



IMPACT WRENCHES IMPACT WRENCHES



From light-duty plant maintenance to heavy-duty industrial steel applications,

Eagle Group impact wrenches are available in single hammer, twin hammer, and pin clutch types.

IMPACT WRENCH CLUTCH INFORMATION

Eagle Group's Impact Wrenches are available with various clutch configurations. Choosing the correct clutch depends on application requirements such as weight, vibration, durability, ease of maintenance, torque, and power.



Single Hammer

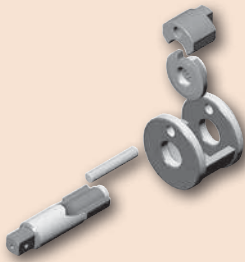

The Single Hammer design is proven and cost effective. It delivers a high torque-to-weight ratio.



Uses

- Standard assembly
- Automotive repair
- Light industrial use

Twin Hammer

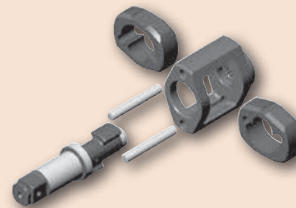

The Twin Hammer design provides a reliable system producing torque quickly with two forged hammers.



Uses

- Industrial maintenance
- Tire service

Pin Clutch

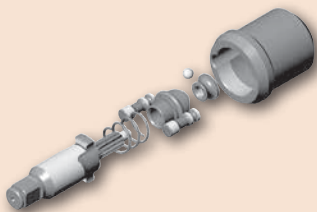

The Pin Clutch design provides rapid delivery of torque and high power-to-weight ratio.



Uses

- Maintenance
- Light assembly
- Hard joints

Swing Hammer

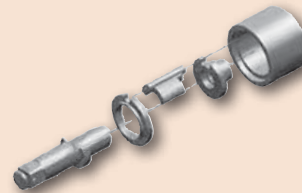

The Swing Hammer Clutch is a simple, effective design that provides rapid delivery of torque.



Uses

- Standard assembly applications
- Maintenance
- Hard joints

3/8" - 1" IMPACT WRENCHES

2010

3/8" Single Hammer Diecast Aluminum Impact Wrench

- Single hammer design
- Air inlet swivels 360° for easy maneuvering
- For bench work, carburetors, ignitions, body panels, transmissions, fender struts, oil pans, and small engine work
- Butterfly throttle allows one-hand directional changes



GENERAL DUTY



WORKING TORQUE: 260 FT-LB

2260L

1/2" Twin Pin Composite Impact Wrench

- Engineered for the after-market automotive industry
- Pin clutch design to quickly deliver torque
- 2-1/2" extended anvil

2P-155034

3/4" Twin Hammer Composite Impact Wrench

INDUSTRIAL DUTY



WORKING TORQUE: 1,000 FT-LB

2P-15501

1" Twin Hammer Composite Impact Wrench



WORKING TORQUE: 1,750 FT-LB

- Extremely lightweight with ergonomic handle configuration
- Proportional trigger for operator control
- Recessed torque output selector in CW direction: Low-Mid-High
- Reverse (CCW) always delivered with maximum power
- Swiveling 360° air inlet
- Reliable 7-vane air motor for consistent power delivery

Model	Application	Housing	Hammer	Drive Size	Approx. Speed (rpm)	Torque Range		Max Torque		Weight		Length		Air Usage (cfm)	Air Inlet
						ft-lb	Nm	ft-lb	Nm	lb	kg	in	mm		
3/8" Wrench															
2010	General	Aluminum	Single	3/8"	10,000	11 - 75	15 - 102	92	125	2.8	1.3	6.4	163	13	1/4"
1/2" Wrench															
2260L	General	Composite	Twin pin	1/2"	7,500	114 - 260	154 - 352	302	409	6.15	2.8	7.5	194	12	1/4"
3/4" Wrench															
2P-155034	Industrial	Composite	Twin	3/4"	6,000	625 - 1,250	850 - 1,690	1,400	1,890	6.7	3.05	8.2	209	7	3/8"
1" Wrench															
2P-15501	Industrial	Composite	Twin	1"	5,000	500 - 2,000	678 - 2,710	2,250	3,050	13	5.9	10	256	12	1/2"

1" - 1-1/2" IMPACT WRENCHES

2450 / 2450L

1" Twin Hammer Sandcast Aluminum Impact Wrenches

INDUSTRIAL DUTY



WORKING TORQUE: 1,450 FT-LB

- Twin hammer design
- Smooth power in a compact, lightweight design
- 2450 with standard 3" anvil
- 2450L with 6" extended anvil

2463

1" Twin Hammer Steel Impact Wrenches

INDUSTRIAL DUTY



WORKING TORQUE: 1,300 FT-LB

- Twin hammer design
- Steel clutch housing protects hammer mechanism
- For tire changing on trucks and buses
- 6" anvil

INDUSTRIAL DUTY



WORKING TORQUE: 3,000 FT-LB

2S-290015

1-1/2" Pinless Lightweight Heavy-Duty Impact Wrench

- High power-to-weight ratio
- Inside trigger design for safety
- Reversible D handle for ergonomic handling of the tool by right or left handed operators
- Efficient air motor design for best use of air pressure and volume on most job sites

Model	Application	Housing	Hammer	Drive Size	Approx. Speed (rpm)	Torque Range		Max Torque		Weight		Length		Air Usage (cfm)	Air Inlet
						ft-lb	Nm	ft-lb	Nm	lb	kg	in	mm		
1" Wrenches															
2450 2450L	Industrial	Sandcast aluminum	Twin	1"	6,000	940 - 1,450	1,274 - 1,965	1,600	2,169	19	8.5	19.5	495	26	1/2"
2463	Industrial	Steel	Twin	1"	3,900	670 - 1,300	908 - 1,760	1,600	2,169	20.2	9	22	559	26	1/2"
1-1/2" Wrench															
2S-290015	Industrial	Aluminum	Swing	1-1/2"	4,000	750 - 3,000	1,016 - 4,050	3,300	4,455	33.7	15.3	24.4	620	12	1/2"

RATCHET WRENCHES

RATCHET WRENCHES

If you need to reach small bolts in tight places,
Eagle Group's ergonomic ratchet wrenches are the tools you need. These wrenches are ideally suited for light and medium duty industrial and maintenance applications, including body shop work, water pumps, radiators, spark plugs, air conditioning, and light assembly.

>> RATCHET WRENCHES

3115 1/4" Ratchet Wrench

GENERAL DUTY

- Rear exhaust with silencer
- Extended ratchet housing for greater reach
- For smaller fasteners



WORKING TORQUE: 18 FT-LB

GENERAL DUTY



WORKING TORQUE: 55 FT-LB

3105 1/2" Ratchet Wrench

- Excellent for general purpose use
- Improved gear head extends life
- Powerful for tough jobs

3320 1/2" Ratchet Wrench

INDUSTRIAL DUTY

- Excellent for general purpose use
- Improved gear head extends life
- Powerful for tough jobs
- Patented head design for increased durability



WORKING TORQUE: 80 FT-LB

3/8" RATCHET WRENCHES

3100

GENERAL DUTY



WORKING TORQUE: 24 FT-LB

- Ball & needle bearing construction for long life
- Internal ring gear with three planetary gears

3205

GENERAL DUTY



WORKING TORQUE: 30 FT-LB

- Composite grip for increased operator comfort
- Built-in grease fitting for lubrication ease

3220

INDUSTRIAL DUTY



WORKING TORQUE: 80 FT-LB

- Composite grip for increased operator comfort
- Built-in grease fitting for lubrication ease
- Patented head design for increased durability

Model	Application	Housing	Drive Size	Approx. Speed (rpm)	Approx. Torque		Weight		Length		Air Usage (cfm)	Air Inlet
					ft-lb	Nm	lb	kg	in	mm		
3115	General	Aluminum/steel	1/4"	230	18	24	1.4	0.6	8	203	10	1/4"
3100	General	Aluminum/steel	3/8"	160	24	33	2.6	1.2	10.5	267	16	1/4"
3205	General	Composite/steel	3/8"	160	30	40	2.5	1.1	10.5	267	18	1/4"
3220	Industrial	Composite/steel	3/8"	280	80	109	2.7	1.2	10.9	277	4	1/4"
3105	General	Aluminum/steel	1/2"	150	55	74	3.1	1.4	14.5	368	21	1/4"
3320	Industrial	Aluminum/steel	1/2"	280	80	109	2.7	1.2	10.9	277	4	1/4"

ASSEMBLY TOOLS

ASSEMBLY TOOLS



*Available in a variety
of clutch styles and
torque ranges,*

Eagle Group's ergonomic screwdrivers are the go-to tools for furniture, woodworking, motor home, boat, RV, van conversion, and appliance industries.

ASSEMBLY TOOL CLUTCH INFORMATION

The variety of Eagle Group's assembly clutch tools ensures that you match the right tool with your application's requirements for precision, speed, power, torque, type of draw, or screw size.

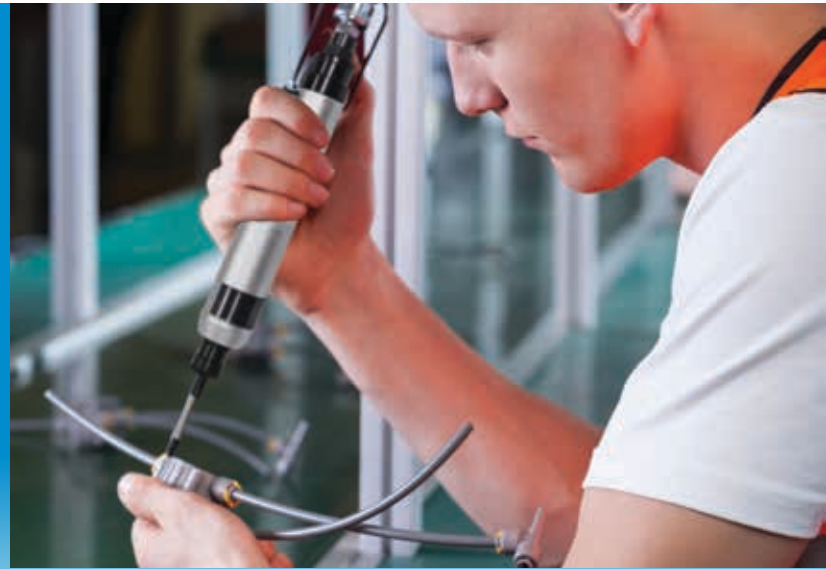

Adjustable Clutch



The adjustable clutch ratchets upon reaching torque. It provides general torque control.

Uses

- General assembly
- Woodworking

Benefits:

- Wide torque range
- High torque output
- High speed

Stall



With a stall clutch, the air motor stalls out upon reaching torque. Torque is proportionate to the air pressure setting.

Uses

- Woodworking
- Soft joints
- Sheet metal screws

Benefits:

- Small, light tool
- Simple maintenance
- Torque adjusted by air pressure

Impact



An impact clutch has a twin hammer impact mechanism.

Uses

- Industrial maintenance
- Tire service
- Heavy assembly

Benefits:

- Fast cycle times

Positive Clutch



A positive clutch ratchets upon reaching torque. Operator can increase torque output with forward/downward pressure.

Uses

- General assembly
- High prevailing torque
- Woodworking
- Soft joints

Benefits:

- Can provide higher rundown torque than seated torque
- Wide torque range

STALL & ADJUSTABLE CLUTCH SCREWDRIVERS

1101 1/4" Stall Screwdriver

GENERAL DUTY

- 1/4" quick change chuck
- High power-to-weight ratio



TORQUE RANGE: 10 - 45 in-lb

1105 1/4" Stall Screwdriver

INDUSTRIAL DUTY

- 1/4" quick change chuck
- High power-to-weight ratio
- Side trigger for easy one-hand reverse



TORQUE RANGE: 20 - 52 in-lb

7P-0620-1 1/4" Stall Screwdriver

INDUSTRIAL DUTY

- Reversible bar on top enables one-hand operation
- Industrial-grade quick change chuck
- 3 Planet industrial-strength gear train provides durability for heavy-duty applications
- Improved muffler design
- Comfort-grip handle
- Spindle with special heat treatment



TORQUE RANGE: 18 - 45 in-lb

1102 1/4" Adjustable Clutch Screwdriver

GENERAL DUTY

- Cushion clutch
- Handle exhaust directs air away
- Convenient forward/reverse valve



TORQUE RANGE: 55 - 160 in-lb

Model	Application	Housing	Drive Size/ Chuck Capacity	Approx. Speed (rpm)	Approx. Torque Range		Weight		Length		Air Usage (cfm)	Air Inlet	Noise Level db(A)
					in-lb	Nm	lb	kg	in	mm			
1101	General	Sandcast aluminum	1/4" QC	1,800	10 - 45	1.1 - 5.1	3	1.4	7	178	16	1/4"	85
1105	Industrial	Sandcast aluminum	1/4" QC	800	20 - 52	2.3 - 5.9	1.5	0.7	5.1	130	14	1/4"	83
7P-0620-1	Industrial	Sandcast Aluminum	1/4" QC	2,000	18 - 45	3.2 - 8	2.3	1	8.5	216	4	1/4"	88
1102	General	Aluminum	1/4" QC	1,800	55 - 160	6.2 - 20.8	2.6	1.2	8.8	222	16	1/4"	83

POSITIVE CLUTCH & IMPACT SCREWDRIVERS

POSITIVE CLUTCH SCREWDRIVERS

1115

1121

GENERAL DUTY



INDUSTRIAL DUTY



TORQUE RANGE: 60 - 40 ft-lb

TORQUE RANGE: 14 - 35 ft-lb

- 1/4" quick change chuck
- High power-to-weight ratio
- For wood and general assembly

	1115	1121
Application	General	Industrial
Housing	Aluminum	Sandcast aluminum
Drive Size/ Chuck Capacity	1/4" QC	1/4" QC
Approx. Speed (rpm)	1,800	1,800
Approx. Torque Range	16 - 40 ft-lb 21.5 - 53.7 Nm	14 - 35 ft-lb 18.8 - 46.9 Nm
Weight	2.6 lb / 1.2 kg	2.5 lb / 1.1 kg
Length	8" / 203 mm	6.8" / 171 mm
Air Usage (cfm)	16	16
Air Inlet	1/4"	1/4"
Noise Level db(A)	88	88

1577

1/4" Impact
Screwdriver

- 7 vane high speed motor
- Totally enclosed pinless impact mechanism with advanced heat treatment
- Tease throttle with 4-stop regulator for speed control and torque output
- 360° adjustable rear exhaust
- Detachable belt clip

INDUSTRIAL DUTY



TORQUE RANGE: 10 - 65 ft-lb

Model	Application	Housing	Drive Size/ Chuck Capacity	Approx. Speed (rpm)	Approx. Torque Range		Weight		Length		Air Usage (cfm)	Air Inlet	Noise Level db(A)
					ft-lb	Nm	lb	kg	in	mm			
1577	Industrial	Sandcast Aluminum	1/4" QC	10,000	10 - 65	13.4 - 88.1	2.3	1.04	6.5	165	29	1/4"	94

Signature Series **CORDLESS TOOLS**

**SIW SHUT-OFF
IMPACT
WRENCH**

INDUSTRIAL DUTY



SERIES TORQUE RANGE: 2 - 89 ft-lb

- Operates as a standard impact wrench or as an impact wrench with a programmable shut-off point
- Brushless motor provides longer motor life and increased efficiency
- Easy-to-read process information lights
- LED light for work-area illumination
- Programmable buttons
- Mini USB port for connection to optional programmer (SPC-2PGM)
- Li-Ion battery provides long battery life

SIW SERIES ACCESSORIES

SIW-B20LI
Li-Ion Battery

- 20V, 2.0 Ah



SIW-B20LI-HC
High Capacity Li-Ion Battery

- 20V, 4.0 Ah



SIW-C18-20
Battery Charger

- Output: 18 - 20V, 4.0 Ah
- Input: 100 - 240VAC, 50 - 60 Hz



BJ10091
Body Jacket Cover



SIW-PBL
Suspension Bail



SIW-38PR (3/8" Dr.)
SIW-50PR (1/2" Dr.)
Pin Retainer Kits



>> ASSEMBLY TOOLS

Model	Application	Housing	Drive Size	Approx. Speed (rpm)	Approx. Torque Range		Max Torque		Battery V	Weight		Noise Level db(A)
					ft-lb	Nm	ft-lb	Nm		lb	kg	
SIW-P2525Q	Industrial	Composite	1/4" QC	2,400	2 - 18	3 - 25	30	40	20	2.2	1	71
SIW-P3225Q	Industrial	Composite	1/4" QC	2,400	4 - 24	6 - 32	66	90	20	2.2	1	71
SIW-P3238	Industrial	Composite	3/8" Sq Dr	2,400	4 - 24	6 - 32	66	90	20	2.2	1	71
SIW-P5538	Industrial	Composite	3/8" Sq Dr	2,400	11 - 41	15 - 55	90	120	20	2.4	1.1	71
SIW-P5550	Industrial	Composite	1/2" Sq Dr	2,400	11 - 41	15 - 55	90	120	20	2.4	1.1	71
SIW-P10050	Industrial	Composite	1/2" Sq Dr	2,400	18 - 74	25 - 100	133	180	20	2.4	1.1	71
SIW-P12050	Industrial	Composite	1/2" Sq Dr	2,400	22 - 89	30 - 120	155	210	20	2.9	1.3	71

Shut-Off Impact Tools Include: Body Jacket, Bail, and one (1) 18V Li-Ion Battery

Signature Series CORDLESS TOOLS

SPC PRECISION CLUTCH TOOLS

INDUSTRIAL DUTY

SERIES TORQUE RANGE: 0.6 - 74 ft-lb



- LED indicator provides simple process information to the operator. The signal is visible from any angle
- Press button for easy F/R operation
- LED light for working in dark areas
- Trigger repeat protection avoids double hits on already seated screws
- Easily attached sliding battery system
- Mini USB port for connection to optional programmer (SPC-2PGM)
- Li-Ion battery pack delivers longer run time
- Ergonomic handle design provides outstanding balance and weight and is ideal for accessing hard-to-reach locations
- Angle tool enables multiple head positions

Model	Application	Housing	Drive Size	Free Speed Range (rpm)	Approx. Torque Range		Battery V	Weight		Noise Level db(A)
					ft-lb	Nm		lb	kg	
Pistol Nutrunner*										
SPC-P2325Q	Industrial	Composite	1/4" QC	500 - 1,550	0.6 - 2.2	0.8 - 3	18	2.1	0.95	75
SPC-P2625Q	Industrial	Composite	1/4" QC	300 - 1,000	0.7 - 4.4	1.0 - 6	18	2.1	0.95	75
SPC-P2925Q	Industrial	Composite	1/4" QC	300 - 800	1.1 - 6.6	1.5 - 9	18	2.1	0.95	75
SPC-P21225Q	Industrial	Composite	1/4" QC	250 - 600	1.5 - 8.8	2 - 12	18	2.1	0.95	75
Right Angle Nutrunner**										
SPC-A21025Q	Industrial	Composite	1/4" QC	400 - 1,000	2.2 - 8.8	3 - 12	18	3.5	1.6	75
SPC-A21025	Industrial	Composite	1/4" Sq	400 - 1,000	2.2 - 8.8	3 - 12	18	3.5	1.6	75
SPC-A21038	Industrial	Composite	3/8" Sq	400 - 1,000	2.2 - 8.8	3 - 12	18	3.5	1.6	75
SPC-A21625Q	Industrial	Composite	1/4" QC	300 - 600	3.7 - 13.3	5 - 18	18	3.5	1.6	75
SPC-A21625	Industrial	Composite	1/4" Sq	300 - 600	3.7 - 13.3	5 - 18	18	3.5	1.6	75
SPC-A21638	Industrial	Composite	3/8" Sq	300 - 600	3.7 - 13.3	5 - 18	18	3.5	1.6	75
SPC-A23038	Industrial	Composite	3/8" Sq	250 - 480	5.9 - 22	8 - 30	18	3.5	1.6	75
SPC-A23538	Industrial	Composite	3/8" Sq	220 - 330	7.4 - 25.8	10 - 35	18	3.5	1.6	75
SPC-A25038	Industrial	Composite	3/8" Sq	200 Non-Programmable Fixed Speed***	7.4 - 37	10 - 50	18	5.3	2.4	75
SPC-A27038	Industrial	Composite	3/8" Sq	170 Non-Programmable Fixed Speed***	14.8 - 51.7	20 - 70	18	6.3	2.9	75
SPC-A210050	Industrial	Composite	1/2" Sq	119 Non-Programmable Fixed Speed***	26 - 74	35 - 100	18	7.4	3.4	75

* Pistol Grip Tools include: Torque Adjustment Tool and one (1) 18V Li-Ion Battery

** Angle Nutrunners include: Torque Adjustment Tool, Head Indexing Spanner Wrench, and one (1) 18V Li-Ion Battery

*** High torque tools feature fixed RPM

Signature Series CORDLESS TOOLS

SPC SERIES ACCESSORIES

SPC-B218LI Li-Ion Battery

- 18V, 2.0 Ah



SPC-B218LI-HC High Capacity Li-Ion Battery

- 18V, 4.0 Ah



SPC-C218-20 Battery Charger

- Output:
18 - 19.2V, 3.0 Ah
- Input:
100 - 240VAC, 50 - 60 Hz



BJ10082 Pistol Tool Body Jacket Cover



BJ10083 Angle Tool Body Jacket Cover



21226 Tool Basket

- Designed for Signature Series pistol and angle tools
- Can be affixed to a bench or rack



SPC-QC Quick Clip

- Designed for Signature Series pistol tools
- Comes with a belt clip and a stretch cord attachment
- Ball feature allows for quick and easy release



TOOL SPEED PROGRAMMER



SPC-2PGM

Each Signature Series battery tool has programmable features that enhance operator efficiency. Programmable features include:

- Tool speed control from minimum (1,500 rpm) to maximum (2,400 rpm) speed in 50 rpm increments
- Forward/Reverse Mode - Three setting options
- Two-stage trigger delay control
- Screw count / impact count
- Supervisor level "lock-out" control

Additionally, the Signature Series battery tool has an integrated mini USB connector that couples to the Signature Series Programmer module. Simply connect the tool to the Programmer Module and flash the tool to the desired RPM. The programmed RPM will remain until a change is desired.

DRILLS

DRILLS

*Rugged construction,
powerful air motors,
and varied RPMs*

provide you many options for selecting the ideal Eagle Group drill for your job. These drills are designed for precision drilling, honing, hole sawing, wood boring, counter-sinking, and wire brushing applications.

DRILLS

7110 3/8" Reversible Drill

- Easy reach reverse selector
- Equipped with Jacobs Chuck®
- Bottom handle exhaust



7650 3/8" Reversible Angle Drill

GENERAL DUTY



- For general purpose drilling in confined areas
- Convenient forward/reverse button
- Rear exhaust
- Equipped with Jacobs Chuck®

7100 3/8" Inline Drill, Non-Reversible

- Inline design for tight space applications
- Ribbed steel housing for better grip



Model	Application	Housing	Chuck Capacity	Reversible/ Non-Reversible	Approx. Power (hp)	Approx. Speed rpm	Weight		Length		Air Usage (cfm)	Air Inlet
							lb	kg	in	mm		
7110	General	Composite/ steel	3/8" Jacobs	Reversible	0.6	1,800	1.8	0.8	7.2	184	13.7	1/4"
7650	General	Aluminum/steel	3/8" Jacobs	Reversible	0.6	1,500	2.3	1	8.3	211	14	1/4"
7100	General	Aluminum/steel	3/8"	Non-Reversible	0.4	1,500	2.3	1	9	229	16	1/4"

7102
3/8" Reversible Drill

- Positive action trigger controls speed
- For drilling, counter sinking, and wire brushing



7107
3/8" Non-Reversible Drill

- Positive action trigger controls speed
- For drilling, counter sinking, and wire brushing



Model	Application	Housing	Chuck Capacity	Reversible/ Non-Reversible	Approx. Power (hp)	Approx. Speed rpm	Weight		Length		Air Usage (cfm)	Air Inlet
							lb	kg	in	mm		
7102	General	Sandcast aluminum/steel	3/8"	Reversible	0.5	1,800	3	1.4	7	178	16	1/4"
7107	General	Aluminum/steel	3/8"	Non-reversible	0.6	2,600	4	1.8	7	178	20	1/4"

VARIABLE-SPEED INDUSTRIAL DRILLS

REVERSIBLE

714P-2100R
1/4" Drill

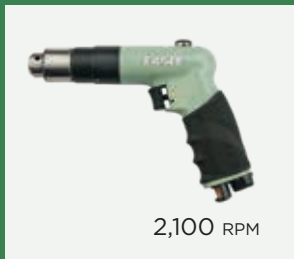

NON-REVERSIBLE

738P-3200
3/8" Drill

712P-420
1/2" Drill



- Precision machined gears
- Robust sandcast aluminum housing
- Steel front end
- Ergonomic handle design
- Equipped w/Jacobs Chuck®
- Variable speed trigger
- Muffled directional rear exhaust

Model	Application	Housing	Chuck Capacity	Reversible/ Non-Reversible	Approx. Power (hp)	Approx. Speed (rpm)	Weight		Length		Air Usage (cfm)	Air Inlet
							lb	kg	in	mm		
714P-2100R	Industrial	Sandcast aluminum/steel	1/4" Jacobs	Reversible	0.6	2,100	1.6	0.73	6.87	175	16	1/4"
738P-3200	Industrial	Sandcast aluminum/steel	3/8" Jacobs	Non-reversible	0.6	3,200	2.65	1.2	7.25	184	16	1/4"
712P-420	Industrial	Sandcast aluminum/steel	1/2" Jacobs	Non-reversible	1	420	2.95	1.34	8.5	216	16	1/4"

GENERAL DUTY



800 RPM

7106

1/2" Reversible Drill

- Positive action trigger controls speed
- For drilling, counter sinking, and wire brushing

Model	Application	Housing	Chuck Capacity	Reversible/ Non-Reversible	Approx. Power (hp)	Approx. Speed (rpm)	Weight		Length		Air Usage (cfm)	Air Inlet
							lb	kg	in	mm		
7106	General	Aluminum/ steel	1/2"	Reversible	0.6	800	4	1.8	7	178	20	1/4"

ONE-HAND OPERATION, INDUSTRIAL REVERSIBLE DRILLS

- Reversible bar on top enables one-hand operation
- Industrial-grade chuck
- 3 Planet industrial-strength gear train provides durability for heavy-duty drilling
- Improved muffler design
- Comfort-grip handle
- Spindle with special heat treatment



Keyed

7P-0620-2: 1/4"
7P-0620-4: 3/8"



Keyless

7P-0620-5: 3/8"
7P-0620-7: 1/2"

Model	Application	Housing	Chuck Capacity	Reversible/ Non-Reversible	Approx. Power (hp)	Approx. Speed (rpm)	Weight		Length		Air Usage (cfm)	Air Inlet
							lb	kg	in	mm		
Keyed												
7P-0620-2	Industrial	Sandcast aluminum/ steel	1/4"	Reversible	0.6	2,000	2.3	1	8.5	216	4	1/4"
7P-0620-4	Industrial	Sandcast aluminum/ steel	3/8"	Reversible	0.6	2,000	2.3	1	8.5	216	4	1/4"
Keyless												
7P-0620-5	Industrial	Sandcast aluminum/ steel	3/8"	Reversible	0.6	2,000	2.3	1	8.5	216	4	1/4"
7P-0620-7	Industrial	Sandcast aluminum/ steel	1/2"	Reversible	0.6	2,000	2.3	1	8.5	216	4	1/4"

PERCUSSION TOOLS PERCUSSION TOOLS



*Tough jobs
require tough tools*

and Eagle Group's durable hammers, chippers, and needle scalers offer the long-lasting power you need for both general and industrial applications. Ideal for foundries, fabrication shops, shipbuilding, and construction applications.

AIR HAMMERS



4100
Air Hammer
2.375" Stroke

- Positive action trigger controls speed
- Heavy-duty spring retainer

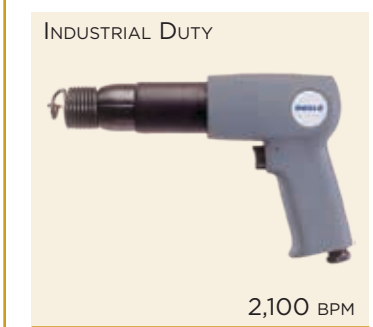

4178
Air Hammer
3.625" Stroke

- Heavy-duty spring retainer
- Long lasting
- For front end, exhaust, frame, and body work



4001
Air Hammer
2.625" Stroke

- Economical air hammer for fast cutting action
- For muffler and pipe removal, body shop work, scraping rust, and light front-end work
- For exhaust system, panel cutting, and general repair work
- Includes 6" chisel with 1-3/8" angle blade

4009
Chipping Hammer
2" Stroke

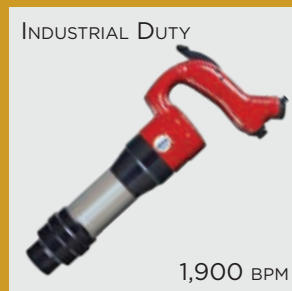

4010
Chipping Hammer
3" Stroke

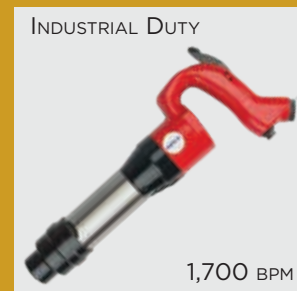

- Drop forged handle
- Front exhaust
- Oval collar
- For paint, scale, and rust removal

Model	Application	Housing	For use with	Chisel Shank	Bore (in)	Stroke (in)	Approx. bpm	Weight lb	kg	Length in	mm	Air Usage (cfm)	Air Inlet
4100	General	Aluminum/steel	Chisel	0.401"	0.75	2.375	2,100	3.3	1.5	7.8	198	10	1/4"
4001	General	Aluminum/steel	Chisel	0.401"	0.75	2.625	3,500	3.8	1.7	6.8	171	15	1/4"
4178	Industrial	Aluminum/steel	Chisel	0.401"	0.75	3.625	2,100	4.3	2	8.5	216	12	1/4"
4009	Industrial	Aluminum/steel	Chisel	.68 round or .58 hex bushing	1.125	2.0	1,900	16	7.3	15.5	394	12	1/2"
4010	Industrial	Aluminum/steel	Chisel	.68 round or .58 hex bushing	1.125	3.0	1,700	17.8	8.1	16.3	413	12	1/2"

NEEDLE SCALERS & FLUX CHIPPERS

4004
Flux Chipper
1.5" Stroke

4005
Needle Scaler
1.5" Stroke

4005SC
Needle Scaler/
Chipper, 1.5" Stroke

INDUSTRIAL DUTY



4,600 BPM

4,600 BPM

4,600 BPM

- Hardened barrels and strict tolerances for maximum life
- Scaler: For foundries, fabrication shops, ship building, and construction
- Chipper: For rust weld slag, and old paint removal

	4004	4005	4005SC
Application	Industrial		
Housing	Steel		
For Use With	7" Angle Chisel (730224C)	Needles (9024/9043)	Needles (9024/9043) 7" Angle Chisel (730224C)
Needle/Chisel Diameter	Chisel: 0.401"	19 @ 3 mm each	19 @ 3 mm each Chisel: 0.373"
Bore	1"		
Stroke	1.5"		
Approx. BPM	4,600		
Weight	5.8 lb / 2.6 kg	6.2 lb / 2.8 kg	6.2 lb / 2.8 kg
Length	9.8" / 248 mm	18" / 457 mm	18" / 457 mm
Air Usage (cfm)	12		
Air Inlet	1/4"		

ACCESSORIES

9024 / 9043
Replacement
Needles

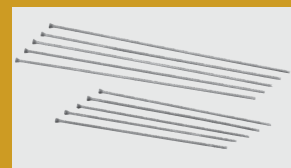

For 4005, 4005SC, 4615, and 4620 needle scalars. Sold as individual needles (see tool set requirements).

	Length	Diameter
9024	7" 175 mm	1/8" 3.18 mm
9043	5" 127 mm	1/8" 3.18 mm

730224C
7" Angle Chisel



For 4004 and 4005SC flux chippers

4615
Mini Needle Scaler
2.375" Stroke

INDUSTRIAL DUTY



4,000 BPM

- Straight handle for hard-to-reach areas
- 12-piece 3 mm needle set included
- For rust, weld slag, and old paint removal

4620
Pistol Needle Scaler
2.375" Stroke

INDUSTRIAL DUTY



4,500 BPM

- Heavy-duty scaler with pistol grip
- 28-piece 3 mm needle set included
- For rust, weld slag, and old paint removal

Model	Application	Housing	For use with	Needle/Chisel Diameter	Bore (in)	Stroke (in)	Approx. bpm	Weight		Length		Air Usage (cfm)	Air Inlet
								lb	kg	in	mm		
4615	Industrial	Steel	Needles (9024/9043)	12 @ 3 mm each	1	2.375	4,000	2.8	1.3	11.5	292	4	1/4"
4620	Industrial	Aluminum/steel	Needles (9024/9043)	28 @ 3 mm each	1	2.375	4,500	8	3.6	13.8	351	7	1/4"

CUTTING & SPECIALTY TOOLS

CUTTING & SPECIALTY TOOLS



Eagle Group offers a variety of speciality tools, including saws, cut-off tools, tire buffers, and blow guns.

PALM BEVELER & SAWS

PALM BEVELER

DL-5216AL Palm Beveler

INDUSTRIAL DUTY

- Lightweight, ergonomic design easily operated with one hand
- Adjustable speed and angle
- Safety lever prevents accidental tool start
- Low vibration
- 360° Exhaust Cover



Model	Application	Approx. Speed (rpm)	Approx. Power (hp)	Beveling Capacity		Dimensions (L x H)		Weight		Air Usage (cfm)	Exhaust	Air Inlet	Noise Level (dbA)
				Steel, Aluminum, Brass 13 Gauge	Stainless Steel 18 Gauge	in	mm	lb	kg				
DL-5216AL	Industrial	30,000	0.25	C0.1 - C2.0 mm	C0.1 - C1.2 mm	5 x 2.5	127 x 63.5	1.06	0.48	15	Rear	1/4"	81

* Mitsubishi inserts part #TCMT080204

6050 Reciprocating Saw

GENERAL DUTY

9,500 SPM

- High performance motor provides aggressive cutting action
- Insulated handle
- For cutting plastics, fiberglass, and sheet metal

6080 Low-Vibration Reciprocating Saw

INDUSTRIAL DUTY

10,000 SPM

- 35% longer stroke for "quicker and thicker" material cuts
- Patented vibration-damped cylinder design decreases vibration emission by 40%
- Patented blade guard prevents metal filing from entering the inner mechanism

Model	Application	Housing	Approx. spm	Teeth	Stroke (mm)	Weight		Length		Air Usage (cfm)	Air Inlet
						lb	kg	in	mm		
6050	General	Aluminum	9,500	14 / 24 / 32	10	2.2	1	9.3	236	7	1/4"
6080	Industrial	Aluminum	10,000	24 / 32	14	1.37	0.62	8.9	227	2.3	1/4"

CUTTING & SPECIALTY

SAWS & CUT-OFF TOOLS

INDUSTRIAL BACK-GOUGING ANGLE SAWS

5A-0514-2
Back-Gouging
Mini Saw



0.5 HP

- Industrial-grade and compliant tool design ensures fast and effective back-gouging
- Angle height: 1.75"
- 2" carbide tooth blade (#5A-0514-2CB) sold separately
- For gouging tight access seams

BLADE SOLD SEPARATELY

5G-10125
5" Angle Saw



1.0 HP

- Left/right hand use
- Governed motor
- Removable base plate
- Side to Side: 31 mm from front blade edge to shoe edge
- Depth Cut Adjustment:
Min: 1/8" (3 mm)
Max: 1" (12.5 mm)



BLADE SOLD SEPARATELY

Model	Application	Housing	Max Blade Diameter	Arbor	Power (hp)	Approx. Speed (rpm)	Max. Blade Exposure	Throttle Type	Exhaust	Weight		Length		Air Usage (cfm)	Air Inlet
										lb	kg	in	mm		
5A-0514-2	Industrial	Steel	2"	3/8"-24	0.5	14,000	—	Lever	Side	3	1.4	8.5	216	15	1/4"
5G-10125	Industrial	Aluminum	5"	5/8"-11	1.0	12,000	0.75"	Lever	Rear	3.95	1.8	11	279	30	3/8"

5205-2EC
3" Cut-Off Tool, 105°



GENERAL DUTY

15,000 RPM

- Ergonomic and safe use design
- 105° angled head design provides improved sight lines and spark angle
- Tight access use
- 1/16" to 1/4" wheel capability

6812EC
3" Cut-Off Tool



INDUSTRIAL DUTY

20,000 RPM

- Lightweight and durable ergonomic composite housing with a soft comfortable grip
- Less noise, vibration, and thermal transfer than aluminum tools
- Protective metal guard

6191
3" Cut-Off Tool



INDUSTRIAL DUTY

24,000 RPM

- Rear exhaust directs exhaust air away
- Lock-off throttle prevents accidental start-up
- For cutting muffler clamps, and use in body shops

Model	Application	Housing	Max. Disc Size	Approx. Speed (rpm)	Weight		Length		Air Usage (cfm)	Air Inlet
					lb	kg	in	mm		
5205-2EC	General	Composite	3"	15,000	1.5	0.68	8.25	210	12	1/4"
6812EC	Industrial	Composite	3"	20,000	1.7	0.77	7.38	187	3	1/4"
6191	Industrial	Aluminum	3"	24,000	2	0.9	8	203	10	1/4"

TOOLS FOR THE TIRE INDUSTRY

UG-60S-29

1/4" 0.50 HP Low-Speed Tire Buffer

- Low speed allows for powerful smooth buffing with no burning or scorching of work surface
- Contoured, ergonomic handle
- Rear muffled exhaust
- Includes spanner wrench to tighten collet



UG-65EBL-ASSY

0.60 HP Horizontal Lightweight Tire Buffer

- Rear muffled exhaust
- Designed for medium-sized tire repair
- Excellent with carbide contour or vane wheels up to 2-1/2"
- Four-bearing construction guarantees long life under heavy usage



USG-4VL

0.60 HP Horizontal Tire Buffer

- Lightweight grinder allows one-hand operation
- Quiet rear exhaust and muffler
- For surface preparation work
- Eliminates heavy shaft drag, dramatically reducing operator fatigue



UG-1250LM

1.0 HP Horizontal Tire Buffer

- Piped away rear exhaust muffles sound and eliminates blowing dust
- Governed motor for fast rubber removal using a cup cutter
- Excellent for inside or outside OTR work and truck rim cleanup with wire brush
- Comes with box muffler and piped away exhaust hose

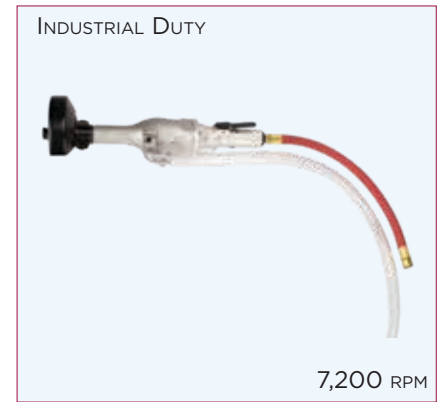

Model	Application	Housing	Collet Size	Capacity (wheel size) in	Approx. Power (hp)	Approx. Speed (rpm)	Throttle Type	Exhaust	Weight		Length		Air Usage (cfm)	Air Inlet
									lb	kg	in	mm		
UG-60S-29	Industrial	Sandcast Aluminum	1/4"	—	0.5	2,900	Lever	Rear	2.3	1.1	8.9	227	18	1/4"
UG-65EBL-ASSY	Industrial	Sandcast Aluminum	—	2.5	0.6	14,600	Lever	Rear	3.1	1.4	10.7	272	22	1/4"
USG-4VL	Industrial	Sandcast Aluminum	—	4	0.6	12,000	Lever	Rear	3.1	1.4	8.7	220	30	1/4"
UG-1250LM	Industrial	Sandcast Aluminum	—	5	1	7,200	Lever	Piped-Away Side	6.2	2.8	17.2	436	32.7	3/8"

ACCESSORIES

ACCESSORIES

*Optimize your
tool's performance*
with Eagle Group's full line
of accessories.

Eagle Group: Your full-service industrial tool source

AUDITOR APTW PRESET TORQUE WRENCHES

Auditor's APTW preset wrenches provide a flexible, easy way to audit fastener torque. A wide range of interchangeable heads provide flexibility and convenience.



- Torque ranges from 5 - 340 Nm
- User friendly, sleek, ergonomic design
- Tactile feedback on achievement of preset torque
- Proprietary adjustment tool guards against unauthorized setting changes
- Wide range of interchangeable heads provide flexibility and convenience
- +/- 3% accuracy when used in clockwise or counterclockwise directions







Wrench Model	Torque Range	Insert Accepted
APTW-25	5 - 25 Nm	12 mm
APTW-50	10 - 50 Nm	12 mm
APTW-100	20 - 100 Nm	12 mm
APTW-150	30 - 150 Nm	12 mm
APTW-200	40 - 200 Nm	14 mm
APTW-340	60 - 340 Nm	14 mm





TORQUE WRENCH INSERTS



Adapters	Description
 APTW-12ADP	9 x 12 M to 14 x 18 F
 APTW-14ADP	14 x 18 M to 9 x 12 F

Ring End Inserts	Description
 APTW-12RE50	1/2" Ring End, 12 mm
 APTW-14RE32	32 mm Ring End, 14 mm

Square Drive Inserts	Description
9 x 12	
 APTW-12SD25	1/4" Sq. Dr.
APTW-12SD38	3/8" Sq. Dr.
APTW-12SD50	1/2" Sq. Dr.
14 x 18	
 APTW-14SD50	1/2" Sq. Dr.

Blank End Inserts	Description
 APTW-12BLANK	12 mm
APTW-14BLANK	14 mm

Open End Head Inserts	
	

Ratchet Heads	Description
9 x 12	
 APTW-12RT25	1/4" Sq. Dr.
APTW-12RT38	3/8" Sq. Dr.
APTW-12RT50	1/2" Sq. Dr.
14 x 18	
 APTW-14RT50	1/2" Sq. Dr.
APTW-14RT34	3/4" Sq. Dr.

9 x 12	Size
APTW-12OE7	7 mm OE
APTW-12OE8	8 mm OE
APTW-12OE9	9 mm OE
APTW-12OE10	10 mm OE
APTW-12OE11	11 mm OE
APTW-12OE12	12 mm OE
APTW-12OE13	13 mm OE
APTW-12OE14	14 mm OE
APTW-12OE15	15 mm OE
APTW-12OE16	16 mm OE
APTW-12OE17	17 mm OE
APTW-12OE18	18 mm OE
APTW-12OE19	19 mm OE
APTW-12OE20	20 mm OE
APTW-12OE50	1/2" OE

14 x 18	Size
APTW-14OE1	1" OE
APTW-14OE13	13 mm OE
APTW-14OE14	14 mm OE
APTW-14OE15	15 mm OE
APTW-14OE16	16 mm OE
APTW-14OE17	17 mm OE
APTW-14OE18	18 mm OE
APTW-14OE19	19 mm OE,
APTW-14OE21	21 mm OE
APTW-14OE22	22 mm OE
APTW-14OE24	24 mm OE
APTW-14OE25	25 mm OE
APTW-14OE27	27 mm OE

14 x 18	Size
APTW-14OE30	30 mm OE
APTW-14OE32	32 mm OE
APTW-14OE34	34 mm OE
APTW-14OE36	36 mm OE
APTW-14OE38	38 mm OE
APTW-14OE41	41 mm OE
APTW-14OE118	1-1/8" OE
APTW-14OE138	1-3/8" OE

AUDITOR TORQUE CUBE



The Auditor Torque Cube (ATC) is a compact, versatile desktop tester that provides a multitude of capabilities. The ATC is designed to test hand or power tools with the following:

- Peak, first peak, and track modes
- Multiple engineering units
- Manual and auto clear function
- Multiple frequency response settings
- Bi-directional use and accuracy
- Accuracy is better than 1% of indicated reading top 90% of range
- Serial data output
- Memory: 999 data samples
- Battery and/or mains powered

Because precision and quality are critical, you can depend on our testers to calibrate and certify your tools. Whether you are assembling large complicated systems or small precise time pieces, AIMCO provides the best system for your application. Our instruments have been judged “best in class” by independent National Standards laboratories. Auditor Torque Cube is rugged enough to test and verify tools at “point of use” while still being accurate enough to calibrate hand and power tools.

Each tester is shipped with a mains/battery charger power cord, a hex to allen drive bit, and a bolting template. Models with max torque of 1,000 in-lb or less also include a joint rundown fixture. The ATC can be positioned vertically or horizontally for the ergonomic testing of inline or pistol grip tools.

Model	Recommended Torque Range		Weight		W x H x D		Sq. Dr.
	Nm	in-lb/ft-lb	kg	lb	mm	in	
Vertical Configuration							
ATC-10	0.13 - 1.13	1 - 10 in-lb	1.13	2.5	79 x 95 x 83	3.13 x 3.75 x 3.25	1/4"
ATC-25	0.28 - 2.83	2.5 - 25 in-lb	1.13	2.5	79 x 95 x 83	3.13 x 3.75 x 3.25	1/4"
ATC-100	1.13 - 11.3	10 - 100 in-lb	1.13	2.5	79 x 95 x 83	3.13 x 3.75 x 3.25	1/4"
ATC-250	2.83 - 28.3	25 - 250 in-lb	1.13	2.5	79 x 95 x 83	3.13 x 3.75 x 3.25	3/8"
Horizontal Configuration							
ATC-150F	20 - 200	15 - 150 ft-lb	2.25	5	79 x 95 x 83	3.13 x 3.75 x 3.25	1/2"

AUDITOR AUET TORQUE TESTERS



AUET



AUET/MTM



AUET/MTM-DC

AUDITOR UNIVERSAL ELECTRONIC TORQUE TESTERS

Auditor Universal Electronic Testers (AUET) have a broad range of features to accommodate most requirements. They are designed to be bench-top mounted and are available in several configurations and various single or multiple torque ranges. Onboard memory allows you to capture 999 torque event readings. The testers are also available in file capability (DC) models that require PC software Auditor Tool Manager (ATM).

Instruments up to 1,000 in-lb are supplied with rundown adapters/joint kits. Rundown kits for larger instruments can be ordered separately. AUET/MTM units are supplied with an external transducer port and selector switch for connecting additional transducers.

AUET testers utilize the same transducers as the ATC instruments, providing the same high quality accuracy and durability. The common interface makes the Auditor tester extremely user friendly.

Single Transducer Models

Model*	Recommended Torque Range
AUET-050(-DC)	5 - 50 in-oz / 0.4 - 3.6 kgf-cm
AUET-0100(-DC)	10 - 100 in-oz / 0.7 - 7.2 kgf-cm
AUET-10(-DC)	1 - 10 in-lb / 1.1 - 11.5 kgf-cm
AUET-50(-DC)	5 - 50 in-lb / 0.5 - 5.6 Nm
AUET-100(-DC)	10 - 100 in-lb / 1.1 - 11.3 Nm
AUET-250(-DC)	25 - 250 in-lb / 2.8 - 28.3 Nm
AUET-500(-DC)	50 - 500 in-lb / 5.7 - 56.5 Nm

* Add "-DC" to part numbers for data collecting models.

Data collecting models allow multiple files/tools/applications to be associated with torque data. Requires Tool Manager software.

Custom sizes are also available. Contact an Eagle Group Customer Service Associate for ordering options, (503) 254-6600, or toll free (800) 852-1368.

Dual Transducer Models

Model*	Recommended Torque Range	
	Transducer 1	Transducer 2
AUET/MTM-050-25	5 - 50 in-oz / 0.04 - 0.4 Nm	2.5 - 25 in-lb / 0.3 - 2.8 Nm
AUET/MTM-050-600(-DC)	5 - 50 in-oz / 0.04 - 0.4 Nm	60 - 600 in-lb / 6.8 - 67.8 Nm
AUET/MTM-0100-050(-DC)	10 - 100 in-oz / 0.07 - 0.71 Nm	5 - 50 in-oz / 0.04 - 0.4 Nm
AUET/MTM-10-100(-DC)	1 - 10 in-lb / 0.11 - 1.12 Nm	10 - 100 in-lb / 1.3 - 11.3 Nm
AUET/MTM-50-250(-DC)	5 - 50 in-lb / 0.56 - 5.65 Nm	25 - 250 in-lb / 2.8 - 28.3 Nm
AUET/MTM-50-500(-DC)	5 - 50 in-lb / 0.56 - 5.65 Nm	50 - 500 in-lb / 5.7 - 56.5 Nm

* Add "-DC" to part numbers for data collecting models.

Data collecting models allow multiple files/tools/applications to be associated with torque data. Requires Tool Manager software.

Custom sizes are also available. Contact an Eagle Group Customer Service Associate for ordering options, (503) 254-6600, or toll free (800) 852-1368.

RUNDOWN FIXTURES

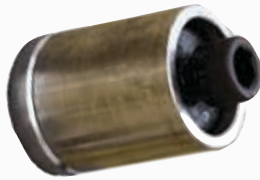

AUDITOR ARDIA RUNDOWN FIXTURES

To test power tools, pneumatic or electric, consistent rotational speed must be achieved. The joint rundown fixture/simulator provides the means by which the tool motor and spindle rotates freely at the start of the test cycle and then develops torque as rotation resistance increases as fastener/joint load increases. The linearity and consistency of the joint rundown fixtures/simulators vary greatly and the tool test data is a product of the variations in these rundown fixtures. Higher quality joint rundown fixtures produce torque data with less scatter.

- Enables accurate and repeatable testing of pneumatic or electric power tools
- Mechanical Belleville system of bolt, nut or nut body, Belleville washers and main housing
- Fixtures can be ordered to simulate hard, medium, or soft joints

ARDIA Models

Model*	Recommended Torque Range		Sq. Dr.
	Nm	in-lb	
ARDIA-10	0.13 - 1.13	1 - 10	1/4"
ARDIA-25	0.28 - 2.8	2.5 - 25	1/4"
ARDIA-50	0.56 - 5.6	5 - 50	1/4"
ARDIA-100	1.3 - 11.3	10 - 100	1/4"
ARDIA-150	1.7 - 16.9	15 - 150	1/4"
ARDIA-250	2.8 - 28.3	25 - 250	3/8"
ARDIA-350	4 - 40	35 - 350	3/8"
ARDIA-500	5.6 - 56.5	50 - 500	3/8"
ARDIA-750	8.5 - 84.7	75 - 750	3/8"
ARDIA-1000	11.3 - 1,000	100 - 113	3/8"

*Add "HD" to part numbers for wear resistant models. Add "HDS" to part numbers for fully encapsulated wear resistant models. Add "HDE" to part numbers for partial encapsulated wear-resistant models.

ARDIA Rundown Fixture connected to an AIMCO AISI transducer.



ERGO-ARM TOOL SUPPORT SYSTEMS

Ergo Arm Series torque reaction arms reduce operator fatigue by absorbing torque transfer from the tool to the operator. Optional tool mounts are available for pistol grip and angle style tools. They are available in single or parallel configurations. Parallel configurations maintain tool perpendicularity to the work piece throughout tool travel. By providing ergonomic support, Ergo-Arms increase productivity, consistency, and accuracy.



AD-D1098-PAC



AAAD-D1098-SAC

PARALLEL ARM SERIES

AD-D1098-P, AD-D1098-PAC, AD-D1098-PACE

- Allows for freedom of movement
- Vertical adjustment eliminates cross-threading
- Fixtured tool increases repeatability
- Adjustable reach
- Available in air or oil cylinder models
- Electric tool mount standard on PACE model

SINGLE ARM SERIES

AD-D1098-S, AD-D1098-SAC

- Full tool rotation
- Allows for freedom of movement
- Adjustable reach
- Compatible with automatic screw feeder
- Available in air or oil cylinder models

Model*	Arm Style	Tool Mount	Reach		Capacity		Max. Torque*	
			in	mm	lb	kg	in-lb	Nm
AIR CYLINDER SERIES								
AD-D1098-SAC	Single	Air manifold	4 - 33	102 - 838	0 - 15	0 - 7	110	12
AD-D1098-PAC	Parallel	Air manifold	4 - 33	102 - 838	0 - 15	0 - 7	110	12
AD-D1098-PACE	Parallel	Electric	4 - 33	102 - 838	0 - 15	0 - 7	110	12
OIL CYLINDER SERIES								
AD-D1098-S	Single	Air manifold**	4 - 33	102 - 838	0 - 15	0 - 7	110	12
AD-D1098-P	Parallel	Air manifold	4 - 33	102 - 838	0 - 15	0 - 7	110	12

* Max torque allowed may be dependent on tool clutch type and joint rate

** For single arm electric tool mount, order EAP-202ED-KIT

SPECIAL FEATURES OF CLASSIC STYLE ERGO-ARM

Dual ball bearing joint construction for smoother movement and long life

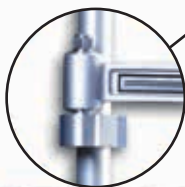

Air regulator offers precision adjustment of resistance for perfect balance

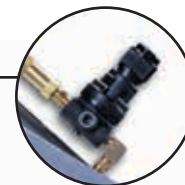

Unique upper rail adjustment allows true vertical approach to any fastener — no cross-threading



WORKSTATION COMPONENTS & ASSEMBLIES

COMPONENTS

TRACK

Steel with beige polyester finish. Use for vertical and horizontal workstation support.



Part #	Length
30# Track	
AT3-3	3 ft track
AT3-4	4 ft track
AT3-6	6 ft track
AT3-9*	9 ft track
50# Track	
AT5-3	3 ft track
AT5-4	4 ft track
AT5-6	6 ft track
AT5-9*	9 ft track
AT5-12*	12 ft track

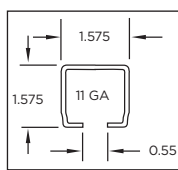
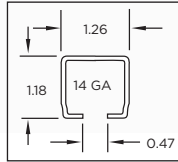

TRACK NUT (ATN-3/5)

Zinc plated steel. Use to attach accessories to track, as end stops, or to isolate rolling accessories.

- ATN-3 for 30 lb. track
- ATN-5 for 50 lb. track



END STOP (AES-3/5)

Zinc oxide finish. Use to prevent balancer trolley from "overtraveling" horizontal track.

- AES-3 for 30 lb. track
- AES-5 for 50 lb. track

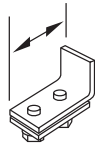

MOUNTING PLATE (AMP-5)

Black polyester finish. Use as a base to mount vertical uprights.

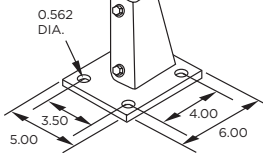

END CAP (AEP-3/5)

Black molded vinyl. Use to cap track ends for a professional finish.

- AEP-3 for 30 lb. track
- AEP-5 for 50 lb. track



ANGLE BRACKET (AB-3/5)

Black polyester finish. Use to mount horizontal track to vertical track.

- AB-3 for 30 lb. track
- AB-5 for 50 lb. track

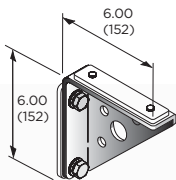

JOINT HANGER BRACKET (AJH-3/5)

Black polyester finish. Use to couple and hang end-to-end track.

- AJH-3 for 30 lb. track
- AJH-5 for 50 lb. track

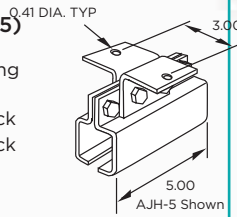

BALANCER TROLLEY (ABT-3/5)

Black polyester finish. Use as moving support for tool balancers, hose, and cable. Quality ball bearing wheels for long life and smooth tracking.

- ABT-3 for 30 lb track (1.00 dia)
- ABT-5 for 50 lb track (1.25 dia)

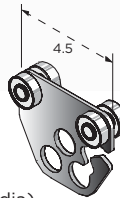

HANGER BRACKET (AHB-3/5)

Black polyester finish. Use to suspend track at right angle.

- AHB-3 for 30 lb. track
- AHB-5 for 50 lb. track

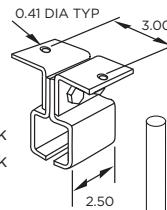

VERTICAL COLUMN (AVC-5*)

Beige polyester finish, 3" diameter x 9 ft upright steel column with welded base.

Use as floor mount for extra stability with jibs or workstation components.



HOSE/CABLE TROLLEY

Black polyester finish. Use for moving cable or hose festoon. Supports hose cable OD .60-.94.

- AIC5-2 for 50 lb. track

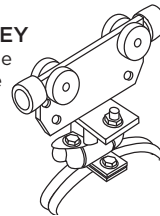

U-BOLTS (AUB-5)

Zinc plated steel. Use to secure boom bracket, or any flat metal plate, to AVC-5 (sold individually).



SUPPORT CLAMPS (ASC-3/5)

Black polyester finish. Use as additional support for track.

- ASC-3 for 30 lb. track
- ASC-5 for 50 lb. track

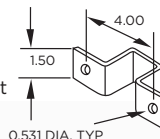

TOOL CLIP (SH-5)

Steel clip with safety latch. Use for tool attachment and as replacement clip for lightweight tool balancers. Length: 2.37"



90° CONNECTOR FOR 3/8" HOSE (WSCH)

3/8" I.D. Brass. Use to provide stable transfer point from air line to tool. 90 degree connector attaches to ABT-5.

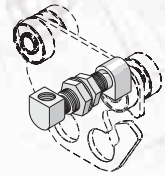

WALL AND FLOOR MOUNTED JIBS

3 FT. SWINGING JIB (AW3S)

3 FT. FIXED JIB (AW3F)

3 FT. SWINGING JIB FOR CHANNEL MOUNT (AJS3**)

Jibs are mounted to wall or beams to create free standing workstations. End stop, end cap, and balancer trolley included. Maximum weight: 30 lb.

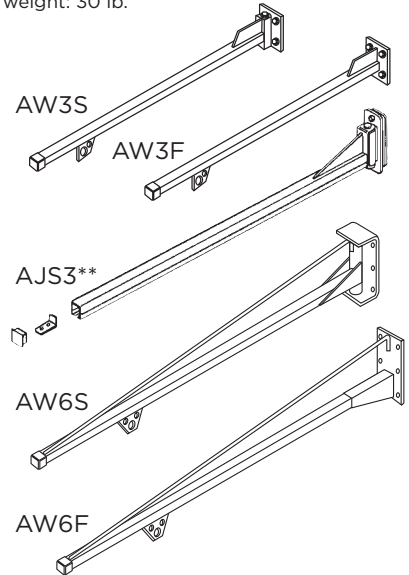

6 FT. SWINGING JIB (AW6S)

6 FT. FIXED JIB (AW6F)

Jibs can be wall mounted or attached to vertical column (AVC-5) to create a freestanding workstation. End stop, end caps, and balancer trolley are included. Maximum weight: 50 lb.

All complete assemblies are beige polyester finish and include balancer trolley, end caps, and end stops. Floor mounted assemblies are not able to ship via UPS.

When choosing a workstation system, remember...

Total weight capacities should include tool balancer, hose/cable, and tool/fixture. Units need to be supported vertically and horizontally every 6 ft.

** Additional freight may apply

** AJS3 Does not include balancer trolley

WORKSTATION COMPONENTS & ASSEMBLIES

**FLOOR MOUNTED
3 FT. FIXED JIB*
(AW3FMF)**
Maximum weight: 30 lb
Column height: 6 ft

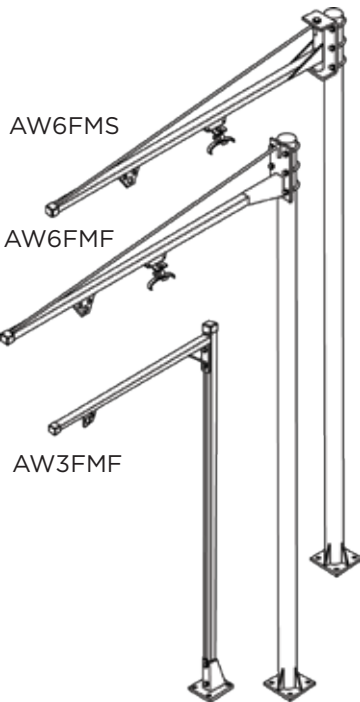

AW6FMS

**FLOOR MOUNTED
6 FT. SWINGING
JIB* (AW6FMS)**

AW6FMF

**FLOOR MOUNTED
6 FT. FIXED JIB*
(AW6FMF)**
Maximum weight: 50 lb
Column height: 9 ft

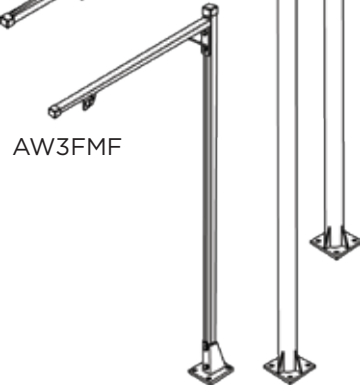

AW3FMF

*Units include end stop, balancer trolley and intermediate carrier.

**BENCH MOUNTED
SWINGING JIB (JJ30-S)**



JJ30-S

**BENCH MOUNTED
FIXED JIB (JJ30)**
Maximum weight: 30 lb
Column height: 48" including mounting plate
3 ft. swinging jib includes balancer trolley, end stop, and cap

AIMCO WORKSTATION KIT

**BENCH MOUNTED WORKSTATION
WITH TORQUE ARM (JJ30-TA**)**

- 5 lb. maximum weight (RPA-3 included)
- 5' column height including mounting plate
- 38" jib length (swinging)
- 15 ft-lb torque rating
- 3/8" NPT inlet
- 1/4" NPT outlet
- Beige polyester finish
- 1/4" braided air hose
- 21" maximum vertical arm travel

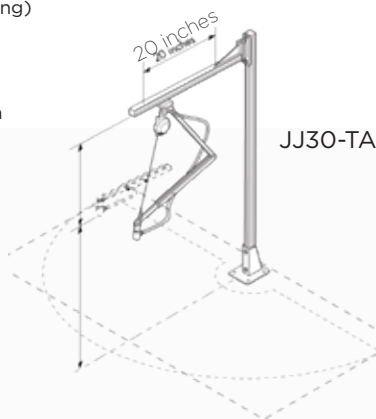

JJ30-TA

** Additional freight may apply
** For use with pneumatic tools only

CREATE A CUSTOM SUPPORT SYSTEM

- Organize work area to create a safe, productive working environment
- Reduce risk of injury to assembler by providing support for heavy tools
- Protect valuable tools, fixtures, and monitoring devices from damage by suspending them out of the way

AIMCO BASIC WORKSTATION KIT (ATW-50)



- 50 lb maximum weight capacity
- 48" uprights
- 36" extensions
- Table mounts included
- 6' tool rail with rolling trolley included
- All necessary hardware included

TROLLEY MOUNTED TORQUE ARM WITH 3-LB RETRACTOR AND HOSE (FA-50-2*)

Ergonomic arm absorbs torque reaction. Moves front to back along overhead jib.

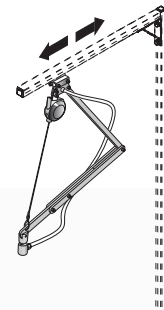

(TA-50-2)
Moves side to side on overhead track.



TOOL BASKET (21226)
Mounts easily to any work area to hold pistol and angle style tools.

Eagle Group can customize a workstation for you.
Contact an Eagle Group Customer Service Associate (503) 254-6600, or toll free (800) 852-1368.

BALANCERS & RETRACTORS

TW SERIES BALANCERS

TW-0 and TW-00

- Gravity defying / “true balance”
- No tension buildup to cause worker fatigue
- Easy external direct drive tensioning
- 360° upper swivel
- Safety cable provision
- Tool clip included

TW-3 through TW-70

- Tapered drum allows “true balance” throughout cable travel
- Easy external direct drive tensioning
- Cast aluminum casing for durability
- Permanent lubrication
- 360° top swivel
- Enclosed spiral spring for added safety
- Safety chain provision (TW-3 through TW-15 models)
- Automatic safety lock plus manual drum lock (TW-22 through TW-70)



Model	Capacity		Anti-Gravity Capacity (lb)	Cable
	lb	kg		
TW-00	1.1 - 3.3	0.5 - 1.5	2.5 - 3	18" stranded steel cable 1/8" dia.
TW-0	1.1 - 3.3	0.5 - 1.5	2.5 - 3	3.3-ft stranded steel cable 1/8" dia..
TW-3	2.2 - 6.6	1 - 3	4.5 - 6	4.3-ft stranded steel cable 5/32" dia.
TW-5	5.5 - 11	2.5 - 5	8 - 10.5	4.3-ft stranded steel cable 5/32" dia.
TW-9	9.9 - 19.8	4.5 - 9	15 - 19	4.3-ft stranded steel cable 5/32" dia.
TW-15	19.8 - 33	9 - 15	26 - 32.5	4.3-ft stranded steel cable 5/32" dia.
TW-22	33 - 48.4	15 - 22	41 - 48	5-ft stranded steel cable 3/16" dia.
TW-30	48.4 - 66	22 - 30	58 - 65.5	5-ft stranded steel cable 3/16" dia.
TW-40	66 - 88	30 - 40	77.5 - 87.5	5-ft stranded steel cable 3/16" dia.
TW-50	88 - 110	40 - 50	100 - 109.5	5-ft stranded steel cable 3/16" dia.
TW-60	110 - 132	50 - 60	122 - 131	5-ft stranded steel cable 3/16" dia.
TW-70	132 - 154	60 - 70	144 - 153	5-ft stranded steel cable 3/16" dia.

RETRACTORS

RPA Series

- No tools needed to set tension
- 5 ft nylon coated steel cable
- Adjustable cable stop
- Tool clip included
- Model series supports weight range 0.5 - 5 lb
- Reinforced hanging bracket includes safety cable provision

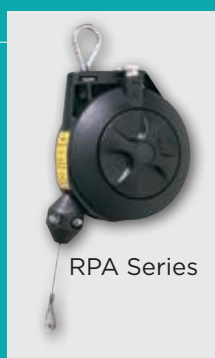

RMA-L Series

- Steel housing with polyester finish
- Ratchet cable lock
- Permanently lubricated
- Tool clip included
- External tension adjustment
- Reinforced hanging bracket includes safety cable provision
- 8 ft of 3/32" diameter coated steel cable



Model	Capacity
RPA-1	0.5 - 1.5 lb 0.2 - 0.7 kg
RPA-2	1.5 - 3 lb 0.7 - 1.4 kg
RPA-3	3 - 5 lb 1.4 - 2.3 kg
RMA-7L	5 - 10 lb* 2.3 - 4.8 kg*
RMA-15L	10 - 15 lb* 4.5 - 6.8 kg*
RMA-20L	15 - 23 lb* 6.8 - 10.4 kg*

* With ratchet lock

BALANCERS & RETRACTORS

ASB-SERIES BALANCERS

- **Built-in Safety Features:** The cable, drum, and enclosed spring are fully visible without opening the unit for easy and convenient safety checks. The sturdy spiral spring is enclosed for greater control and safety
- **Ergonomic Spring Release:** The automatic safety lock provides extra control
- **Extended Cable Length:** Stainless steel cables allow for extended reach on applications
- **Enhanced Gear Mechanism:** Allows for more exact adjustment of tension
- **No Recoil and Low Resistance:** Tapered drum style provides gravity defying tool positioning and low travel



ASB-OC Gravity Defying and Hand Adjustable Balancer



ASB-3C
ASB-5C

Model	Capacity		Stroke		Weight	
	lb	kg	in	cm	lb	kg
ASB-OC	1.1 - 3.3	0.5 - 1.5	51.1	130	1.5	0.7
ASB-3C	3.3 - 6.6	1.5 - 3	86.4	220	3.0	1.4
ASB-5C	5.5 - 11	2.5 - 5	86.4	220	3.4	1.5

LR SERIES LINE REEL BALANCERS

- Designed for light duty applications with small pneumatic tools
- Integrating air hose and support cable keep work areas clean
- Adjustable ball stop for optional positioning
- 1/4" I.D. polyvinyl hose with 1/4" NPT inlet
- 360° upper swivel
- Maximum 142 PSI



LR-09B-90/200

Model	Capacity		Hose Length	
	lb	kg	in	cm
LR-09B-90	3	1.5	35.5 in	90
LR-09B-200	3	1.5	78.3	199

FRL FILTER/REGULATORS

AFRL STACKING FILTERS/REGULATORS

Stacking filter/regulator combinations provide air filtration and precise regulation in a single unit for easy mounting and installation.

- All models include L-mount bracket, gauge, and metal bowl shields
- Polycarbonate filter and lubricator bowls (metal bowls standard on AFRL-8)
- 25-micron filter included on all models
- Regulating range: 7 - 125 PSI
- Custom order upgrade items include metal bowl, 5 micron filter, semi-automatic filter drain, and reduced PSI range regulator. Contact an Eagle Group Customer Service Associate for more information, (503) 254-6600, or toll free (800) 852-1368
- Maximum allowable Input Pressure not to exceed 120 PSI



AFRL-2-C
AFRL-3-C



AFRL-2
AFRL-3
AFRL-4
AFRL-8

Model	Port	Gauge Port	Flow Rate		Bowl Shield
			CFM	l/min	
AFRL-2	1/4"	1/8"	70	2,000	yes
AFRL-2-C	1/4"	1/8"	60	1,700	yes
AFRL-3	3/8"	1/4"	140	4,000	yes
AFRL-3-C	3/8"	1/4"	105	3,000	yes
AFRL-4	1/2"	1/4"	140	4,000	yes
AFRL-8	1"	1/4"	180	5,000	yes

Dimensions

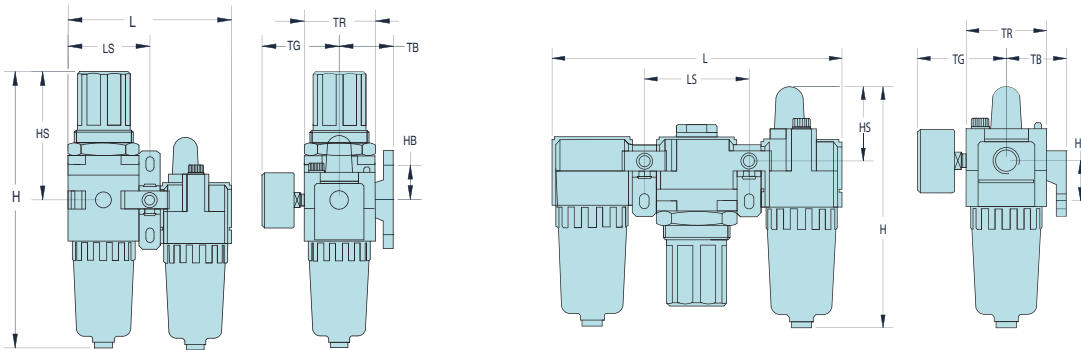

Model	H in/mm	HB in/mm	HS in/mm	L in/mm	LS in/mm	TB in/mm	TG in/mm	TR in/mm
AFRL-2	6.16 (156.5)	1.39 (35.3)	1.50 (38.1)	7.13 (181.1)	2.52 (64)	1.61 (41)	2.39 (60.7)	2.09 (53.1)
AFRL-2-C	8.31 (211.1)	1.38 (35.1)	3.64 (92.5)	4.61 (117.1)	2.30 (58.4)	1.61 (40.9)	2.39 (60.7)	2.09 (53.1)
AFRL-3	7.54 (191.5)	1.57 (40)	1.61 (40.9)	9.37 (238)	3.31 (84.1)	1.97 (50)	2.58 (65.5)	2.76 (70.1)
AFRL-3-C	10.31 (261.9)	1.57 (39.9)	4.41 (112)	6.06 (153.9)	3.03 (77)	1.97 (50)	2.58 (65.5)	2.76 (70.1)
AFRL-4	7.54 (191.5)	1.57 (40)	1.61 (40.9)	9.37 (238)	3.31 (84.1)	1.97 (50)	2.58 (65.5)	2.76 (70.1)
AFRL-8	10.69 (271.5)	1.97 (50)	1.89 (48)	11.81 (300)	4.13 (104.9)	2.75 (69.9)	2.97 (75.4)	3.54 (89.9)

POLYURETHANE AIR HOSE

Single Air Hose Assemblies (Coiled)

- Durable Polyurethane is chemical resistant and lightweight, and provides excellent recoil memory and maximum flexibility
- Available in transparent hose color (opaque also available)
- Assemblies for coiled hose include reusable swivel fitting. Straight hose available with or without fittings
- Working temperature: -104° F to 175° F

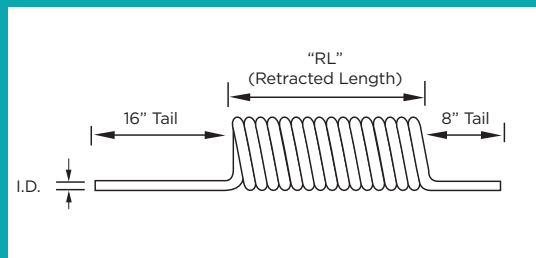

Model	Size (O.D. x I.D. x Length)	Retracted Length	Working Pressure	NPT Fittings
ASH-250C-10MSZ	3/8" x 1/4" x 10'	7"	100 psi	1/4"
ASH-250C-15MSZ	3/8" x 1/4" x 15'	9-1/2"	100 psi	1/4"
ASH-250C-25MSZ	3/8" x 1/4" x 25'	15-1/2"	100 psi	1/4"
ASH-375C-15MSZ	9/16" x 3/8" x 15'	10"	100 psi	3/8"
ASH-375C-25MSZ	9/16" x 3/8" x 25'	14"	100 psi	3/8"
ASH-500C-15MSZ	3/4" x 1/2" x 15'	13"	100 psi	1/2"
ASH-500C-25MSZ	3/4" x 1/2" x 25'	23"	100 psi	1/2"

Custom length coil assemblies and special colors available in minimum order quantities. Contact an Eagle Group Customer Service Associate, (503) 254-6600, or toll free (800) 852-1368.

Straight Air Hose

- Sold per foot
- For full-reel pricing, contact an Eagle Group Customer Service Associate, (503) 254-6600, or toll free (800) 852-1368.



Model	I.D.
ASH-375Z	3/8"
ASH-500Z	1/2"

RUBBER HOSE

- Designed for use in a wide range of industrial, construction, and agricultural applications
- Constructed of high grade, reinforced EPDM synthetic rubber
- Working temperature: -40° F to 190° F



I.D.	O.D.	Length	Working Pressure	Weight
3/16"	0.44"	10 ft	200 psi	0.8 lb
1/4"	0.5"	10 ft	200 psi	0.9 lb
5/16"	0.58"	10 ft	200 psi	1.2 lb
3/8"	0.67"	10 ft	200 psi	1.5 lb
1/2"	0.81"	10 ft	200 psi	2.0 lb
5/8"	0.97"	10 ft	200 psi	2.7 lb
3/4"	1.12"	10 ft	200 psi	3.4 lb

Custom lengths available. Contact an Eagle Group Customer Service Associate, (503) 254-6600, or toll free (800) 852-1368.

AIR LINE ACCESSORIES

BRASS QUICK COUPLERS

Manual ball couplers designed for use with ergonomic twist plugs. Brass with nitrile seals, rated to 300 PSI, from -40° to +250° F.

Model	Description
B23	1/4" NPT F x 1/4" QC
B23E	1/4" NPT F x 3/8" QC
B25	3/8" NPT F x 3/8" QC



ERGONOMIC TWIST PLUGS



These unique, ergonomically designed hose fittings provide 360° rotation and 35° angled rotation in any direction.

- Two rotation points prevent kinking of air hose
- Design ensures full air pressure flow
- Rotating joint has polyurethane dust cover
- Heavy-duty construction

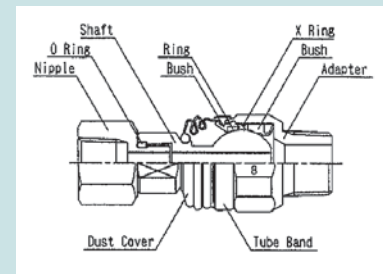

Model	Description
TS-30NP-2NPT	3/8" NPT Female x 1/4" NPT Male
TS-20NP-2NPT	1/4" NPT Female x 1/4" NPT Male
TS-20US-2NPT	1/4" US Plug x 1/4" NPT Male
TS-30US-3NPT	3/8" US Plug x 3/8" NPT Male

MINI AIR GAUGE SWIVEL JOINT KITS

- Bi-directional 360° rotation
- Keeps air hose straight and untwisted
- Decreases operator fatigue



Model	Inlet	Weight	Max PSI	Tool CFM
7021AG	1/4" NPT	3 oz	Up to 125	25
7041AG	3/8" NPT	3 oz	Up to 125	50

SWIVEL AIR FITTINGS

For use with most portable air tools, including grinders, drills, screwdrivers, buffers, sanders, staple guns, and more. Rotates 360° for awkward angles.



Model	Inlet	Weight	Max PSI	Tool CFM
7021	1/4" NPT	3 oz	Up to 125	25
7041A	3/8" NPT	11 oz	Up to 125	50
7051	1/2" NPT	7 oz	Up to 125	60

BRASS ADAPTERS AND BUSHINGS



Pipe fittings for use as medium and low pressure connectors. Meets functional requirements of SAE J530, SAE J531, ASME and ASA. Rated 1,000 PSI from -65° to +250° F.

Model	Description
222P-6-4	3/8" NPT F x 1/4" NPT M Adapter
222P-8-6	1/2" NPT F x 3/8" NPT M Adapter
222P-12-8	3/4" NPT F x 1/2" NPT M Adapter
209P-6-4	1/4" NPT F x 3/8" NPT M Bushing
209P-8-6	3/8" NPT F x 1/2" NPT M Bushing

AIR LINE FITTINGS



Model	Description
375-RZ	1/4" NPT Rigid Fitting
250-RZ	1/4" NPT Swivel Fitting
375-SZ	3/8" NPT Rigid Fitting
375-SZ	3/8" NPT Swivel Fitting
500-SZ	1/2" NPT Swivel Fitting

BITS & SOCKETS

STANDARD FASTENER TOOLS

Connect your tool to the application with Bits, Sockets, and Nutsetters from AIMCO.

AIMCO has assembled a complete package of commonly used screwdriver bits and nutsetters. Our goal is to supply you with the highest quality bits and nutsetters for your fastener needs. Whether you're in electronics, aerospace, automotive, or general industry, AIMCO has the bits and nutsetters to fit your needs.

MAG-O-NETS: A REVOLUTIONARY WAY TO CONVERT STANDARD BITS TO MAGNETIC BITS



- Easy, cost effective alternative to traditional magnetic bit holder and insert bit combination
- Improves torque transfer by eliminating "wobble effect"
- Easily adjust magnetic attraction by moving Mag-O-Net collar closer to or further from fastener
- Fits virtually any standard screwdriver bit
- Reusable and interchangeable — once a bit is worn out, simply remove your Mag-O-Net and slide it onto the next bit
- Lifetime guarantee on magnetic attraction

Part #	ID	OD	L
AM1/4Z	7 mm	19 mm	10 mm
AM5Z	6 mm	17.5 mm	10 mm
AM3/16Z	3/16 in	17.5 mm	10 mm
AM5/16Z	5/16 in	10 mm	10 mm

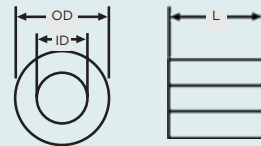

MARKER SOCKETS

Marker Sockets paint the bolt head at the same time the torque is checked. Sockets are designed to your specification.

- Unit consists of a marker socket, an ink cartridge, a spring, and the cartridge cap
- Cartridge can be inserted/taken off easily for ink management
- Easily replaceable paint point
- Can be used with either oil-based or water-based inks
- When ordering, provide dimensions shown. To order, contact an Eagle Group Customer Service Associate (503) 254-6600, or toll free (800) 852-1368

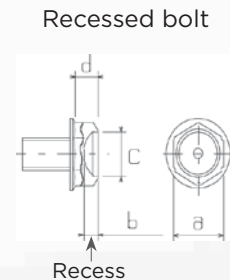
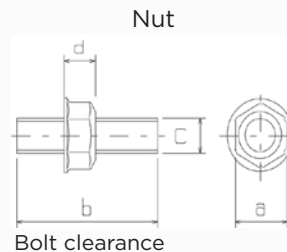
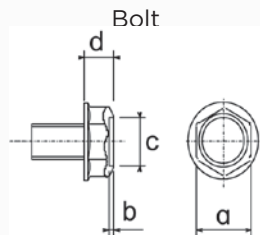

BITS & SOCKETS

IMPACT SOCKETS

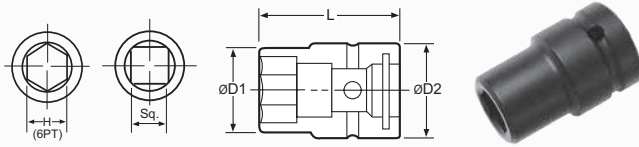

Part #	Hex	D1		D2		L	
		mm	in	mm	in	mm	in

3/8" Square Drive							
SAE	A31/4	1/4"	10	0.39	19	0.75	34 1.34
	A35/16	5/16"	12	0.47	19	0.75	34 1.34
	A33/8	3/8"	15	0.59	19	0.75	34 1.34
METRIC	A306	6 mm	10	0.39	19	0.75	34 1.34
	A307	7 mm	13	0.49	20	0.79	32 1.26
	A308	8 mm	14	0.55	20	0.79	32 1.26

3/8" Square Drive, Deep							
	A307-2	7 mm	13	0.49	20	0.79	50 1.97
	A307-2.75	7 mm	13	0.49	20	0.79	70 2.76
	A308-2	8 mm	14	0.55	20	0.79	50 1.97

3/8" Square Drive, Magnetic							
SAE	A31/4MP	1/4"	10	0.39	19	0.75	34 1.34
	A35/16MP	5/16"	12	0.47	19	0.75	34 1.34
	A33/8MP	3/8"	15	0.59	19	0.75	34 1.34
METRIC	A308MP	8 mm	14	0.55	20	0.79	32 1.26
	A310MP	10 mm	17	0.65	20	0.79	32 1.26
	A311MP	11 mm	17	0.65	19	0.75	34 1.34

1/2" Square Drive							
SAE	A43/8	3/8"	16	0.63	25	0.98	38 1.50
	A47/16	7/16"	18	0.69	25	0.98	38 1.50
	A41/2	1/2"	19	0.75	25	0.98	50 1.97
METRIC	A408	8 mm	16	0.61	25	0.98	40 1.58
	A409	9 mm	16	0.63	25	0.98	40 1.58
	A410	10 mm	18	0.69	25	0.98	40 1.58

Part #	Hex	D1		D2		L	
		mm	in	mm	in	mm	in

1/2" Square Drive, Deep							
SAE	A43/8-3.25	3/8"	17	0.67	25	0.98	82 3.23
	A47/16-3.25	7/16"	19	0.73	25	0.98	82 3.23
	A41/2-3.25	1/2"	22	0.85	25	0.98	82 3.23
METRIC	A410-2	10 mm	18	0.69	25	0.98	50 1.97
	A410-3	10 mm	18	0.69	25	0.98	75 2.95
	A410-3.25	10 mm	17	0.67	25	0.98	82 3.23
	A411-3.25	11 mm	19	0.73	25	0.98	82 3.23

1/2" Square Drive, Magnetic							
	A408MP	8 mm	16	0.61	25	0.98	40 1.58
	A410MP	10 mm	18	0.69	25	0.98	40 1.58
	A412MP	12 mm	21	0.81	25	0.98	40 1.58

3/4" Square Drive							
SAE	A611/16	11/16"	30	1.18	44	1.73	50 1.97
	A63/4	3/4"	32	1.26	44	1.73	50 1.97
METRIC	A613/16	13/16"	35	1.38	44	1.73	50 1.97
	A614	14 mm	24	0.95	38	1.50	55 2.17
	A616	16 mm	27	1.06	44	1.73	50 1.97
	A617	17 mm	30	1.18	38	1.50	55 2.17

3/4" Square Drive, Deep							
SAE	A611/16-4	11/16"	31	1.22	44	1.73	100 3.94
	A63/4-4	3/4"	33	1.30	44	1.73	100 3.94
METRIC	A613/16-4	13/16"	36	1.42	44	1.73	100 3.94
	A617-4	17 mm	31	1.22	44	1.73	100 3.94
	A618-4	18 mm	32	1.26	44	1.73	100 3.94
	A619-4	19 mm	33	1.30	38	1.50	100 3.94

1" Square Drive							
SAE	A87/8	7/8"	37	1.46	54	2.13	59 2.32
	A815/16	15/16"	38	1.50	54	2.13	59 2.32
	A81	1"	41	1.61	54	2.13	59 2.32
METRIC	A817	17 mm	31	1.22	50	1.97	63 2.48
	A819	19 mm	33	1.30	50	1.97	63 2.48
	A821	21 mm	37	1.46	50	1.97	63 2.48

ANTI-MARRING SOCKETS

AIMCO's anti-marring sockets have a protective resin cover that spins freely, preventing damage to application surfaces, and protecting fingers.

To order sockets specific to your application, contact an Eagle Group Customer Service Associate (503) 254-6600, or toll free (800) 852-1368



CV Series



CVF Series



CVF Series with Bit Attachment



BITS & SOCKETS

Allen Sockets

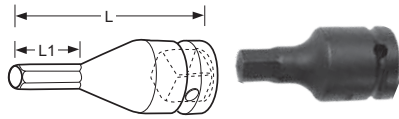

Part #	Hex	L1		L	
		mm	in	mm	in

3/8" Square Drive

A31/4C	1/4"	10	0.39	42	1.65
A304C	4 mm	10	0.39	42	1.65

1/2" Square Drive

A41/4C	1/4"	25	0.98	50	1.97
A405C	5 mm	25	0.98	50	1.97

Universal Sockets

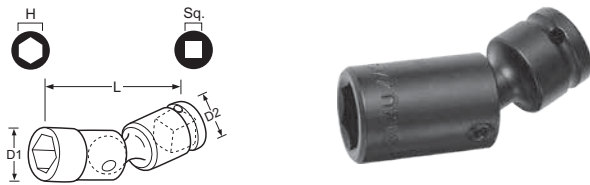

Part #	Hex	D1		D2		L	
		mm	in	mm	in	mm	in

3/8" Square Drive

A310U	10 mm	16	0.63	20	0.79	55	2.17
A311U	11 mm	16	0.63	20	0.79	60	2.36

1/2" Square Drive

A412U	12 mm	20.5	0.81	25	0.98	70	2.76
A413U	13 mm	19	0.75	24	0.95	70	2.76

Extensions

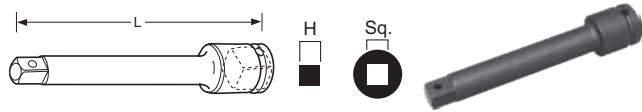

Part #	Sq. Drive		L		D	
	Hex	mm	mm	in	mm	in

A375E	3/8"	3/8"	75	2.95	20	0.79
A405E	1/2"	1/2"	51	2.01	30	1.18
A610E	3/4"	3/4"	100	3.94	44	1.73
A810E	1"	1"	102	4.02	54	2.13
A1220E	1-1/4"	1-1/4"	200	7.87	60	2.36
A1418E	1-1/2"	1-1/2"	178	7.01	84	3.31
A2426E	2-1/2"	2-1/2"	264	10.39	137	5.39

Socket Adapters



Part #	Female	Male	D		L	
	Sq. Drive	Sq. Drive	mm	in	mm	in
A302A	3/8"	1/4"	22	0.87	35	1.38
A403A	1/2"	3/8"	25	0.98	37	1.46
A504A	5/8"	1/2"	35	1.38	47	1.46
A604A	3/4"	1/2"	38	1.50	53	2.09
A806A	1"	3/4"	50	1.97	70	2.76
A128A	1-1/4"	1"	60	2.36	76	2.99
A#508A	Spline #5	1"	60	2.36	90	3.54

Nutsetters

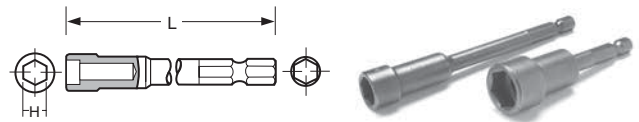

Part #	Hex	L	
		mm	in
A3B1/4-2	1/4"	50	1.97
A3B1/4-2.5	1/4"	63	2.50
A3B5/16-2	5/16"	50	1.97
A3B5/16-2.5	5/16"	63	2.50
A3B3/8-2	3/8"	50	1.97
A3B3/8-2.5	3/8"	63	2.50
A3B05-2.75	5 mm	70	2.76
A3B55-1.2	5.5 mm	30	1.18
A3B55-2.75	5.5 mm	70	2.76
A3B55-4	5.5 mm	100	3.94
A3B06-2.75	6 mm	70	2.76
A3B07-1.2	7 mm	30	1.18
A3B07-2	7 mm	50	1.97
A3B07-2.75	7 mm	70	2.76
A3B07-4	7 mm	100	3.94
A3B08-1.2	8 mm	30	1.18
A3B08-2	8 mm	50	1.97
A3B08-2.75	8 mm	70	2.76
A3B08-4	8 mm	100	3.94
A3B08-6	8 mm	150	5.91
A3B08-8	8 mm	200	7.87
A3B09-2.75	9 mm	70	2.76
A3B09-4	9 mm	100	3.94
A3B10-1.2	10 mm	30	1.18
A3B10-2	10 mm	50	1.97
A3B10-2.75	10 mm	70	2.76
A3B11-2.75	11 mm	70	2.76
A3B12-1.2	12 mm	30	1.18
A3B13-2.75	13 mm	70	2.76
A3B14-2.75	14 mm	70	2.76
A3B16-2.75	16 mm	70	2.76
A3B17-2.75	17 mm	70	2.76

BITS & SOCKETS

Quick Change Chucks

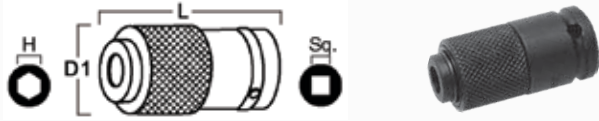

Part #	Sq. Drive	Hex	D1		L	
			mm	in	mm	in
ADC-2S	1/4"	1/4"	19	0.75	38	1.50
ADC-3S	3/8"	1/4"	20	0.79	42	1.65
ADC-4S	1/2"	1/4"	19	0.75	46	1.81
ADC-3SH7/16Z	3/8"	7/16"	25	0.98	46	1.81
ADC-4SH7/16Z	1/2"	7/16"	33	1.30	55	2.17

Phillips Insert Bits

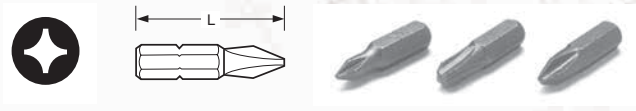

Part No	Point Size	L	
		mm	in
A38S2-1	2	25	0.98
A38S3-1	3	25	0.98

Square Recess Bits

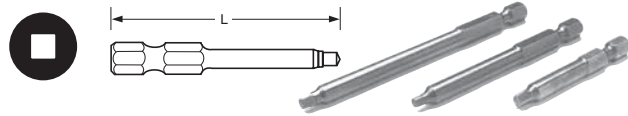

Part No	Point Size	Nominal Square Size	L	
			mm	in
A3R1/8-2.75	2	1/8"	70	2.76
A3R9/64-2.75	3	9/64"	70	2.76

Square Recess Insert Bits

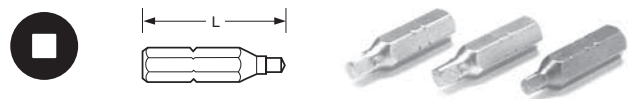

Part No	Point Size	Nominal Square Size	L	
			mm	in
A38R1/8-1	2	1/8"	25	0.98
A38R9/64-1	3	9/64"	25	0.98

Slotted Insert Bits

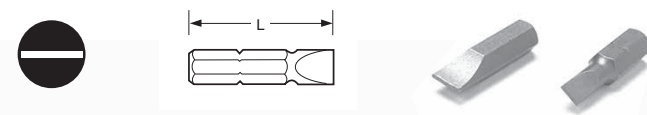

Part No	Screw Size	L		Blade Thickness	Blade Width
		mm	in		
A38M8-1	8	25	0.98	0.04	0.25
A38M10-1	10	25	0.98	0.05	0.28

Phillips Single-Ended Power Bits

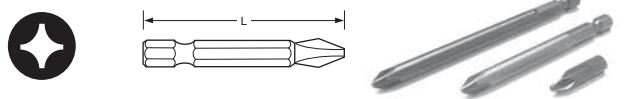

Part #	Point Size	L	
		mm	in
A3S0-2	0	50	1.97
A3S1-2	1	50	1.97
A3S1-2.75	1	70	2.76
A3S1-3	1	75	2.95
A3S1-3.5	1	90	3.54
A3S1-4	1	100	3.94
A3S1-6	1	150	5.91
A3S2-1.2	2	30	1.18
A3S2-1.6	2	40	1.57
A3S3-2	3	50	1.97
A3S3-2.75	3	70	2.76

Phillips Double-Ended Power Bits

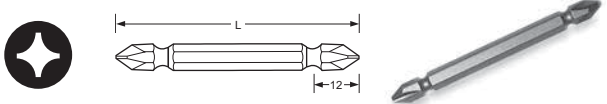

Part #	Size	L	
		mm	in
A3W1-3	1	75	2.94
A3W2-2	2	50	1.97
A3W2-3	2	75	2.94
A3W2-4	2	100	3.94
A3W2-6	2	150	5.91
A3W2-8	2	200	7.87
A3W2-10	2	250	9.84
A3W2-12	2	300	11.81
A3W3-2	3	50	1.97
A3W3-3	3	75	2.94
A3W3-4	3	100	3.94
A3W3-6	3	150	5.91
A3W3-8	3	200	7.87

BITS & SOCKETS

Slotted Power Bits

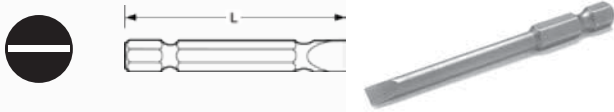

Part #	Screw Size	mm	L in	Blade Thickness	Blade Width
A3M8-3	8	75	2.95	0.04	0.28
A3M10-3	10	75	2.95	0.05	0.31

Torx Power Bits

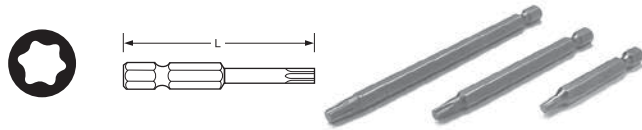

Part #	Torx Size	mm	L in
A3T6-2	T6	50	1.97
A3T7-2	T7	50	1.97
A3T7-2.75	T7	70	2.76
A3T7-3.5	T7	90	3.54
A3T7-6	T7	150	5.91
A3T8-2	T8	50	1.97
A3T9-2.75	T9	70	2.76

Bit Holders



Part #	MM	L IN
1/4" Hex, Magnetic		
A3BHM-3	75	2.94
A3BHM-4	100	3.94
A3BHM-6	150	5.91
A3BHM-8	200	7.87
A3BHM-10	250	9.84

Bit and Nutsetter Part Number Nomenclature

Precedes Part Number

BITS		A7	7/16 Power Drive
A3S	Phillips® Power Drive	AS	Electric Type Phillips®
A3W	Double Ended Phillips®	AM	Electric Type Slotted
A38S	Phillips® Insert	ATW	Electric Type Tri-Wing®
A39S	Phillips® Insert Reduced Nose	AT	Electric Hios Type Torx®
A3M	Slotted Power Drive	A26S	Electric Driver Phillips®
A38M	Slotted Insert	A26M	Electric Driver Slotted
A3MT	Slotted Power Drive Reduced Nose	A26C	Electric Driver Allen Socket Head
A3C	Allen Socket Head Power Drive	A3BHM	Insert Bit Holder (Magnetic Type)
A38C	Allen Socket Head Insert	A3BHD	Insert Bit Holder (Non Magnetic)
A3R	Square Recess Power Drive	NUTSETTERS	
A3RT	Square Recess Turned Down (Power)	A3B	Nutsetter
A38R	Square Recess Insert	A3BMP	Magnetic (MP) Pressed Type
A3T	Torx® Power Drive	A3BMS	Magnetic (MS) Spring Loaded
A38T	Torx® Insert	A3BMT	Magnetic (MT) Tube Type
A3TS	Torq-Set® Power Drive	A3BU	Universal Nutsetter
A38TS	Torq-Set® Insert	MAG-O-NETS	
A3TA	Triangle Power Drive	AM	AIMCO Mag-O-Net®
A3TW	Tri-Wing® Power Drive		
A38TW	Tri-Wing® Insert		

Contained within Part Number

Bits		ACRB	ACR® 4x4 Both Install and Remove
PZ	Pozidriv®	E4	Electric 4mm diameter
PZACR	Pozidriv® ACR®	E5	Electric 5mm diameter
SDV	Supadriv®	RS	Reduced Shank
TR	Torx® Tamper Resistant		
ACRI	ACR® Installation		
ACR	ACR® Remove		

Additional types and sizes of fastener tools, as well as custom parts, are available upon request. Contact an Eagle Group Customer Service Associate at (503) 254-6600, or toll free (800) 852-1368.

RESOURCES

RESOURCES

Eagle Group: Power Tool Solutions











For more information on tools, accessories, service, and training, contact your Eagle Group Customer Service Associate at (503) 254-6600 or (800) 852-1368.

CONVERSION TABLES

Fraction • Decimal • Metric Conversions (to .32)

Fraction	Decimal	mm	Fraction	Decimal	mm	Fraction	Decimal	mm	Fraction	Decimal	mm
1/32	.03125	.7938	9/32	.28125	7.1438	17/32	.53125	13.4938	25/32	.78125	19.8438
1/16	.0625	1.5875	5/16	.3125	7.9375	9/16	.5625	14.2875	13/16	.8125	20.6375
3/32	.09375	2.3812	11/32	.34375	8.7312	19/32	.59375	15.0812	27/32	.84375	21.4312
1/8	.125	3.175	3/8	.375	9.525	5/8	.625	15.875	7/8	.875	22.225
5/32	.15625	3.9688	13/32	.40625	10.3188	21/32	.65625	16.6688	29/32	.90625	23.0188
3/16	.1875	4.7625	7/16	.4375	11.1125	11/16	.6875	17.4625	15/16	.9375	23.8125
7/32	.21875	5.5562	15/32	.46875	11.9062	23/32	.71875	18.2562	31/32	.96875	24.6062
1/4	.25	6.35	1/2	.5	12.7	3/4	.75	19.05	1	1.0	25.4

Thread Size to Hex Size

 Metric Bolt Size	 Socket Hex Size (mm)	 Metric Bolt Size	 Socket Hex Size (mm)	 Metric Bolt Size	 Socket Hex Size (mm)	 SAE Bolt Size	 Socket Hex Size (in)	 UNC Bolt Size	 Socket Hex Size (in)
M 2	4	M 14	21	M 52	80	1/4	7/16	1/4	7/16
M 2.3	4.5	(M 14)	22	M 56	85	5/16	1/2	5/16	1/2
M 2.6	5	M 16	24	M 60	90	3/8	9/16	3/8	9/16
M 3	5.5	M 18	27	M 64	95	7/16	5/8	7/16	11/16
M 3.5	6	M 20	30	M 68	100	1/2	3/4	1/2	3/4
M 4	7	(M 22)	32	M 72	105	9/16	7/8	9/16	7/8
M 5	8	M 22	34	M 76	110	5/8	15/16	5/8	15/16
(M 5-6)	9	M 24	36	M 80	115	3/4	1-1/16	3/4	1-1/8
M 6	10	M 27	41	M 85	120	7/8	1-1/4	7/8	1-5/16
M 7	11	M 30	46	M 90	130	1-1/8	1-7/16	1	1-1/2
M 8	13	M 33	50	M 95	135	1-1/4	1-13/16	1-1/8	1-11/16
(M 8)	14	M 36	55	M 100	145	1-3/8	2	1-1/4	1-7/8
M 10	16	M 39	60	M 105	150	1-1/2	2-3/16	1-3/8	2-1/16
(M 10)	17	M 42	65	M 110	155			1-1/2	2-1/4
M 12	18	M 45	70	M 115	165			1-3/4	2-5/8
(M 12)	19	M 48	75	M 120	170			2	3
								2-1/4	3-3/8
								2-1/2	3-3/4

Torque Conversion Factors

Units to be Converted	SAE			METRIC			INTERNATIONAL SYSTEM - S.I.		
	ozf-in	lbf-in	lbf-ft	gf-cm	kgf-cm	kgf-m	mNm	cNm	Nm
1 ozf-in	1	0.0625	0.005	72	0.072	0.0007	7.062	0.706	0.007
1 lbf-in	16	1	0.083	1152.1	1.152	0.0115	113	11.3	0.113
1 lbf-ft	192	12	1	13826	13.83	0.138	1356	135.6	1.356
1 gf-cm	0.014	0.0009	0.00007	1	0.001	0.00001	0.098	0.01	0.0001
1 kgf-cm	13.89	0.868	0.072	1000	1	0.01	98.07	9.807	0.098
1 kgf-m	1389	86.8	7.233	100000	100	1	9807	980.7	9.807
1 mN-m	0.142	0.009	0.0007	10.2	0.01	0.0001	1	0.1	0.001
1 cN-m	1.42	0.088	0.007	102	0.102	0.001	10	1	0.01
1 N-m	141.6	8.851	0.738	10197	10.20	0.102	1000	100	1

WARRANTY INFORMATION

NEW TOOL AND ACCESSORY WARRANTY

Any new tool or accessory branded with the Eagle name, and purchased from EAGLE GROUP (EAGLE), or through one of its authorized distributors or agents, is warranted to the original buyer against defects in materials and workmanship for a period of one (1) year* from date of delivery. Under the terms of this warranty, EAGLE GROUP will repair or replace any product or accessory warranted hereunder and returned freight prepaid proving to EAGLE GROUP's satisfaction to be defective as a result of workmanship or materials. In order to qualify for this warranty, written notice to EAGLE GROUP must be given immediately upon discovery of such defect, at which time EAGLE GROUP will issue an authorization to return the tool. The defective item must be promptly returned to an authorized EAGLE GROUP service center with all freight charges prepaid.

REPAIRED TOOL WARRANTY

Once a tool is beyond the new product warranty period, as detailed above, EAGLE GROUP will provide repair warranty on pneumatic tools for a period of 90 days* beyond the warranted repair date.

EXCLUSION FROM WARRANTY

This warranty is valid only on products purchased from EAGLE GROUP, or thru its authorized distributors or agents. EAGLE GROUP shall have no obligation pursuant to the EAGLE GROUP Warranty with respect to any tools or accessories which in EAGLE GROUP's sole judgment have been altered, damaged, misused, abused, badly worn, lost or improperly maintained. This Warranty is null and void if the customer, or any other person other than an authorized representative of EAGLE GROUP, has made any attempt to service or modify the tool or accessory prior to its return to EAGLE GROUP under this Warranty.

The warranty provision with respect to each such product may be amended by EAGLE GROUP from time to time in its sole discretion. The liability of EAGLE GROUP hereunder shall be limited to replacing or repairing, at its option, any products which are returned freight prepaid to EAGLE GROUP and which EAGLE GROUP determines to be defective as described above or, at EAGLE GROUP's option, refunding the purchase price of such products.

EAGLE GROUP reserves the right to make periodic changes in construction or tool design at any time. EAGLE GROUP specifically reserves the right to make these changes without incurring any obligation or incorporating such changes or updates in tools or parts previously distributed.

THE EAGLE GROUP WARRANTY IS IN LIEU OF ALL OTHER WARRANTIES, EXPRESSED OR IMPLIED, AND EAGLE GROUP EXPRESSLY DISCLAIMS ANY WARRANTY OF MERCHANTABILITY OR FITNESS FOR A PARTICULAR PURPOSE. THIS WARRANTY SETS FORTH THE SOLE AND EXCLUSIVE REMEDY IN CONTRACT, TORT, STRICT LIABILITY, OR OTHERWISE.

THIS WARRANTY IS THE ONLY WARRANTY MADE BY EAGLE GROUP WITH RESPECT TO THE GOODS DELIVERED HEREUNDER, AND MAY BE MODIFIED OR AMENDED ONLY BY A WRITTEN INSTRUMENT SIGNED BY A DULY AUTHORIZED OFFICER OF EAGLE GROUP.

LIMITATION OF LIABILITY

EAGLE GROUP'S LIABILITY PURSUANT TO WARRANTY OF THE PRODUCTS COVERED HEREUNDER IS LIMITED TO REFUND OF THE PURCHASE PRICE. IN NO EVENT SHALL EAGLE GROUP BE LIABLE FOR COSTS OF PROCUREMENT OF SUBSTITUTE GOODS BY THE BUYER. IN NO EVENT SHALL EAGLE GROUP BE LIABLE FOR ANY SPECIAL, CONSEQUENTIAL, INCIDENTAL OR OTHER DAMAGES (INCLUDING WITHOUT LIMITATION, LOSS OF PROFIT) WHETHER OR NOT EAGLE GROUP HAS BEEN ADVISED OF THE POSSIBILITY OF SUCH LOSS, HOWEVER CAUSED, WHETHER FOR BREACH OR REPUDIATION OF CONTRACT, BREACH OF WARRANTY, NEGLIGENCE OR OTHERWISE. THIS EXCLUSION ALSO INCLUDES ANY LIABILITY WHICH MAY ARISE OUT OF THIRD PARTY CLAIMS AGAINST BUYER. THE ESSENTIAL PURPOSE OF THIS PROVISION IS TO LIMIT THE POTENTIAL LIABILITY OF EAGLE GROUP ARISING OUT OF THIS AGREEMENT AND/OR SALE.

Note: The EAGLE GROUP Warranty confers specific legal rights, however some states or jurisdictions may not allow certain exclusions or limitations within this warranty.

* All warranty periods addressed herein are determined using a standard shift, eight-hour work day.

EAGLE GROUP

Attn: Service Department
10000 SE Pine Street
Portland, OR 97216
800.852.1368

INDEX

MODEL #	PAGE	MODEL #	PAGE	MODEL #	PAGE	MODEL #	PAGE	MODEL #	PAGE	
A										
AB-3	49	APTH-14OE24	44	AUET-50(-DC)	46	SIW-P3238	27	209P-8-6	55	
AB-3/5	49	APTH-14OE25	44	AUET-0100(-DC)	46	SIW-P5538	27	222P-6-4	55	
AB-5	49	APTH-14OE27	44	AUET-250(-DC)	46	SIW-P5550	27	222P-8-6	55	
ABT-3	49	APTH-14OE30	44	AUET-500(-DC)	46	SIW-P10050	27	222P-12-8	55	
ABT-5	49	APTH-14OE32	44	AUET/MTM-10-100(-DC)	46	SIW-P12050	27	250-RZ	55	
AD-D1098-P	48	APTH-14OE34	44	AUET/MTM-050-25	46	SIW-PBL	27	250-SZ	55	
AD-D1098-PAC	48	APTH-14OE36	44	AUET/MTM-50-250(-DC)	46	SPC-2PGM	29	2010	19	
AD-D1098-PACE	48	APTH-14OE38	44	AUET/MTM-50-500(-DC)	46	SPC-A21025	28	2450	20	
AD-D1098-S	48	APTH-14OE41	44	AUET/MTM-050-600(-DC)	46	SPC-A21025Q	28	2463	20	
AD-D1098-SAC	48	APTH-14OE118	44	AUET/MTM-0100-050(-DC)	46	SPC-A21038	28	21226	29, 50	
AEP-3	49	APTH-14OE138	44	AVC-5	49	SPC-A21625	28	28796	54	
AEP-5	49	APTH-14RE32	44	AW3F	49	SPC-A21625Q	28	2P-15501	19	
AES-3	49	APTH-14RT34	44	AW3FMF	50	SPC-A21638	28	2P-155034	19	
AES-5	49	APTH-14RT50	44	AW3S	49	SPC-A23038	28	2S-290015	20	
AFRL-4	53	APTH-14SD50	44	AW6F	49	SPC-A23538	28	375-RZ	55	
AFRL-2	53	APTW-25	44	AW6FMF	50	SPC-A25038	28	375-SZ	55	
AFRL-2-C	53	APTW-50	44	AW6FMS	50	SPC-A27038	28	3100	22	
AFRL-3	53	APTW-100	44	AW6S	49	SPC-A210050	28	3105	22	
AFRL-3-C	53	APTW-150	44	B						
AFRL-8	53	APTW-200	44	B23	55	SPC-B218LI	29	3115	22	
AHB-3	49	APTW-340	44	B23E	55	SPC-B218LI-HC	29	3205	22	
AHB-5	49	ARDIA-10	47	B25	55	SPC-C218-20	29	3220	22	
AIC5-2	49	ARDIA-25	47	BJ10082	29	SPC-P2325Q	28	3320	22	
AJH-3	49	ARDIA-50	47	BJ10083	29	SPC-P2625Q	28	32046-3I-02	6	
AJH-5	49	ARDIA-100	47	D						
AJS3	49	ARDIA-150	47	DL-5216AL	40	SPC-P2925Q	28	4001	36	
AMP-5	49	ARDIA-250	47	F						
APTH-12ADP	44	ARDIA-350	47	FA-50-2	50	SPC-P21225Q	28	4004	37	
APTH-12BLANK	44	ARDIA-500	47	J						
APTH-12OE7	44	ARDIA-750	47	JJ30	50	SPC-QC	29	4005	37	
APTH-12OE8	44	ARDIA-1000	47	JJ30-S	50	TA-50-2	50	4005SC	37	
APTH-12OE9	44	ASB-0C	52	JJ30-TA	50	TS-20NP-2NPT	55	4009	36	
APTH-12OE10	44	ASB-3C	52	L						
APTH-12OE11	44	ASB-5C	52	LR-09B-90	52	TS-20US-2NPT	55	4010	36	
APTH-12OE12	44	ASC-3	49	LR-09B-200	52	TS-20US-3NPT	55	4100	36	
APTH-12OE13	44	ASC-5	49	M						
APTH-12OE14	44	ASH-250C-10MSZ	54	MAG-O-NETS	56	TS-30NP-2NPT	55	4178	36	
APTH-12OE15	44	ASH-250C-15MSZ	54	R						
APTH-12OE16	44	ASH-250C-25MSZ	54	RMA-7L	51	TS-30US-3NPT	55	4615	37	
APTH-12OE17	44	ASH-375C-15MSZ	54	RMA-15L	51	TW-00	51	4620	37	
APTH-12OE18	44	ASH-375C-25MSZ	54	RMA-20L	51	TW-0	51	5A-0514-2	10, 41	
APTH-12OE19	44	ASH-500C-15MSZ	54	RPA-1	51	TW-3	51	5A-0514-2CB	41	
APTH-12OE20	44	ASH-500C-25MSZ	54	RPA-2	51	TW-5	51	5A-1012-5	11	
APTH-12OE50	44	ASH-500Z	54	RPA-3	51	TW-9	51	5A-1676-7	11	
APTH-12RE50	44	AT3-3	49	S						
APTH-12RT25	44	AT3-4	49	SH-5	49	TW-15	51	5A-04122	9	
APTH-12RT38	44	AT3-6	49	SIW-38PR	27	TW-22	51	5A-04202	9	
APTH-12RT50	44	AT3-9	49	SIW-50PR	27	TW-30	51	5G-10125	41	
APTH-12SD25	44	AT5-3	49	SIW-B20LI	27	TW-40	51	5I-03302	6	
APTH-12SD38	44	AT5-4	49	SIW-B20LI-HC	27	TW-50	51	5I-03302F	6	
APTH-12SD50	44	AT5-6	49	SIW-C18-20	27	TW-60	51	5I-04252	7	
APTH-14ADP	44	AT5-9	49	SIW-P2525Q	27	TW-70	51	5I-04252X	8	
APTH-14BLANK	44	AT5-12	49	SIW-P3225Q	27	U				
APTH-14OE1	44	ATC-10	45	UG-60S-29						42
APTH-14OE13	44	ATC-25	45	UG-65-EBL-ASSY						42
APTH-14OE14	44	ATC-100	45	UG-1250LM						42
APTH-14OE15	44	ATC-150F	45	USG-4VL						42
APTH-14OE16	44	ATC-250	45	W						
APTH-14OE17	44	ATN-3	49	WSCH						49
APTH-14OE18	44	ATN-5	49	Numbers						
APTH-14OE19	44	ATW-50	50	1101	25	1102	25	1105	25	
APTH-14OE21	44	AUB-5	49	1115	26	1121	26	1577	26	
APTH-14OE22	44	AUET-10(-DC)	46	209P-6-4	55					

INDEX

MODEL #	PAGE	MODEL #	PAGE	MODEL #	PAGE	MODEL #	PAGE	MODEL #	PAGE
5104	11	A128A	58	A3S3-2.75	59	A411-3.25	57		
5105	11	A1220E	58	A3T6-2	60	A412MP	57		
5110	6	A1418E	58	A3T7-2	60	A412U	58		
5116	8	A2426E	58	A3T7-2.75	60	A413U	58		
5194EC	10	A3M8-3	60	A3T7-3.5	60	A504A	58		
5194EC-KIT	10	A3M10-3	60	A3T7-6	60	A#508A	58		
5195EC	10	A3R1/8-2.75	59	A3T8-2	60	A63/4	57		
5195EC-KIT	10	A3R9/64-2.75	59	A3T9-2.75	60	A63/4-4	57		
5196EC	10	A3M8-1	59	A3W1-3	59	A604A	58		
5196EC-KIT	10	A3M10-1	59			A610E	58		
5200EC	7	A38R1/8-1	59	A3W2-2	59	A611/16	57		
5201EC	7	A38R9/64-1	59	A3W2-3	59	A611/16-4	57		
5202EC	9	A38S2-1	59	A3W2-4	59	A613/16	57		
5203EC	9	A38S3-1	59	A3W2-6	59	A613/16-4	57		
5205-2EC	10, 41	A3B1/4-2	58	A3W2-8	59	A614	57		
5206EC	8	A3B1/4-2.5	58	A3W2-10	59	A616	57		
5207EC	8	A3B3/8-2	58	A3W2-12	59	A617	57		
6005	15	A3B3/8-2.5	58	A3W3-2	59	A617-4	57		
6009	15	A3B05-2.75	58	A3W3-3	59	A618-4	57		
6012	14	A3B5/16-2	58	A3W3-4	59	A619-4	57		
6017	16	A3B5/16-2.5	58	A3W3-6	59	A81	57		
6050	40	A3B06-2.75	58	A3W3-8	59	A87/8	57		
6080	40	A3B07-1.2	58	A31/4	57	A806A	58		
6113	16	A3B07-2	58	A31/4C	58	A810E	58		
6114	16	A3B07-2.75	58	A31/4MP	57	A815/16	57		
6115	16	A3B07-4	58	A33/8	57	A817	57		
6115EC	14	A3B08-1.2	58	A33/8MP	57	A819	57		
6116	16	A3B08-2	58	A35/16	57	A821	57		
6133EC	14	A3B08-2.75	58	A35/16MP	57	ADC-2S	59		
6134EC	14	A3B08-4	58	A302A	58	ADC-3S	59		
6191	41	A3B08-6	58	A304C	58	ADC-3SH7/16Z	59		
6507	14	A3B08-8	58	A306	57	ADC-4S	59		
6812EC	41	A3B09-2.75	58	A307	57	ADC-4SH7/16Z	59		
6905EC	15	A3B09-4	58	A307-2	57	AM1/4Z	56		
6906EC	15	A3B10-1.2	58	A307-2.75	57	AM3/16Z	56		
7P-0620-1	25	A3B10-2	58	A308	57	AM5/16Z	56		
7P-0620-2	34	A3B10-2.75	58	A308-2	57	AM5Z	56		
7P-0620-4	34	A3B11-2.75	58	A308MP	57	CVF Series Anti-Marring Sockets	57		
7P-0620-5	34	A3B12-1.2	58	A310MP	57	CV Series Anti-Marring Sockets	57		
7P-0620-7	34	A3B13-2.75	58	A310U	58	MARK-XXXX Marker Sockets	56		
712P-420	33	A3B14-2.75	58	A311MP	57				
714P-2100R	33	A3B16-2.75	58	A311U	58				
738P-3200	33	A3B17-2.75	58	A375E	58				
7021	55	A3B55-1.2	58	A41/2	57				
7021AG	55	A3B55-2.75	58	A41/2-3.25	57				
7041A	55	A3B55-4	58	A41/4C	58				
7041AG	55	A3BHM-3	60	A43/8	57				
7051	55	A3BHM-4	60	A43/8-3.25	57				
7100	32	A3BHM-6	60	A47/16	57				
7102	33	A3BHM-8	60	A47/16-3.25	57				
7106	34	A3BHM-10	60	A403A	58				
7107	33	A3S0-2	59	A405C	58				
7110	32	A3S1-2	59	A405E	58				
7650	32	A3S1-2.75	59	A408	57				
730224C	37	A3S1-3	59	A408MP	57				
8101	10	A3S1-3.5	59	A409	57				
8102	10	A3S1-4	59	A410	57				
8103	10	A3S1-6	59	A410-2	57				
9024	37	A3S2-1.2	59	A410-3	57				
9043	37	A3S2-1.6	59	A410-3.25	57				
Bits and Sockets		A3S3-2	59	A410MP	57				



AIMCO CORPORATE HEADQUARTERS

10000 SE Pine Street
Portland, Oregon 97216
Phone: (503) 254-6600
Toll Free: (800) 852-1368

AIMCO CORPORATION DE MEXICO SA DE CV

Ave. Cristobal Colon 14529
Chihuahua, Chihuahua. 31125
Mexico
Phone: (01-614) 380-1010
Fax: (01-614) 380-1019